

# KLAUDIUS TYP 1

Art.-Nr.

394 621  
394 613

	700
	1964
	400
	mm

**1/6**  
v0  
16-2024

	50 min			PZ 2, PZ 1	0,5 kg	3m	600 mm	Ø10	

ID	ID			
21084	②	1892*398*16	2x	1/2
21085	③	700*400*22	1x	2/2
21086	④	347*1932*3	2x	1/2
21087	⑤	700*400*22	1x	2/2
21088	⑥	666*394*16	4x	2/2

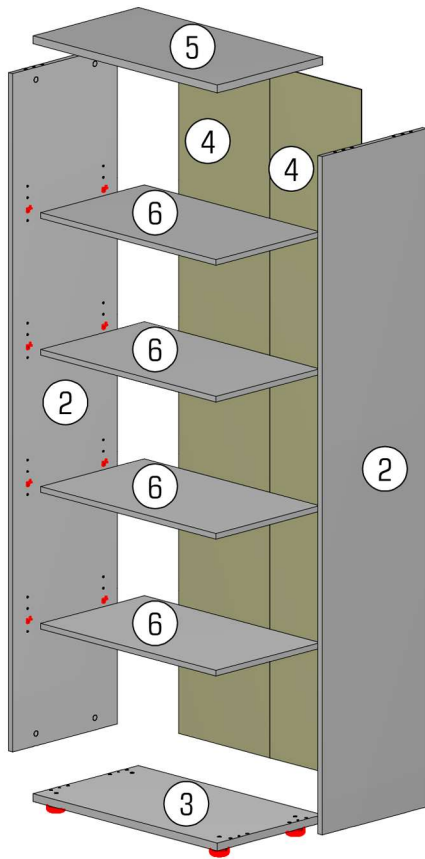
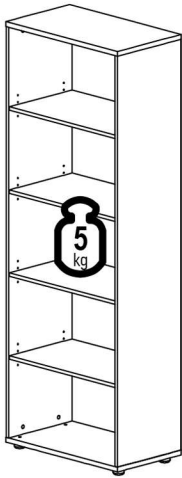



--	--	--	--	--	--



	22800,01		22256,00		22244,01		
A	1x	B	1x	E	2x	F	8x
	24101,00		27000,00		8501,00		30082,01
K	1x	L	16x	M	16x	N	4x
	31103,00		21102,00		70013,01		70021,01
P	1x	T	75x	U	8x	V	8x

--	--	--	--	--	--	--	--	--	--

# 2/6 KLAUDIUS TYP 1

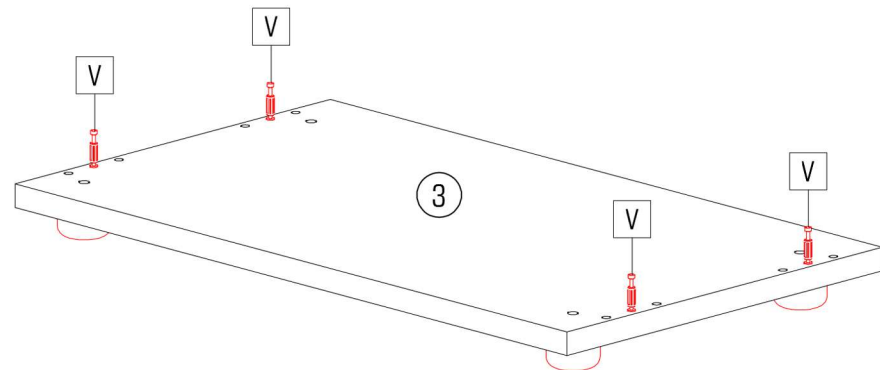
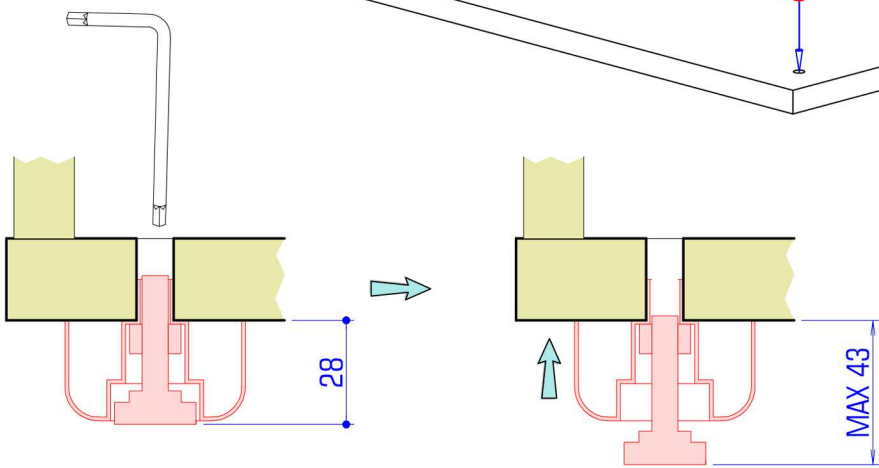
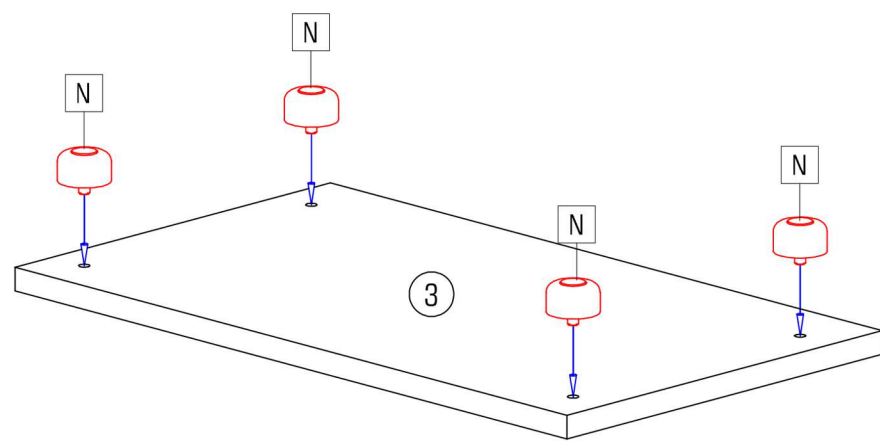
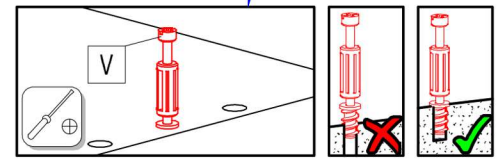
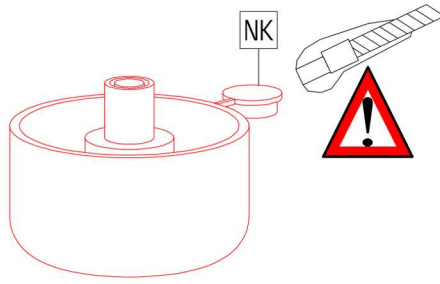
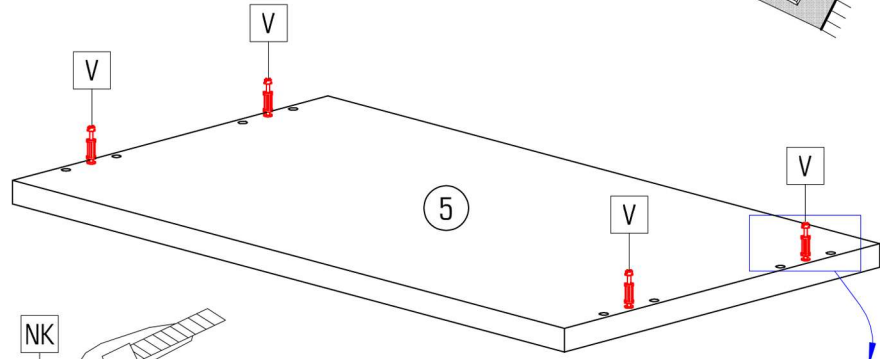
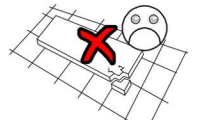
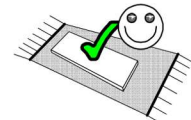
	
Ø50 v=28	
N 4x	V 8x

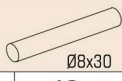



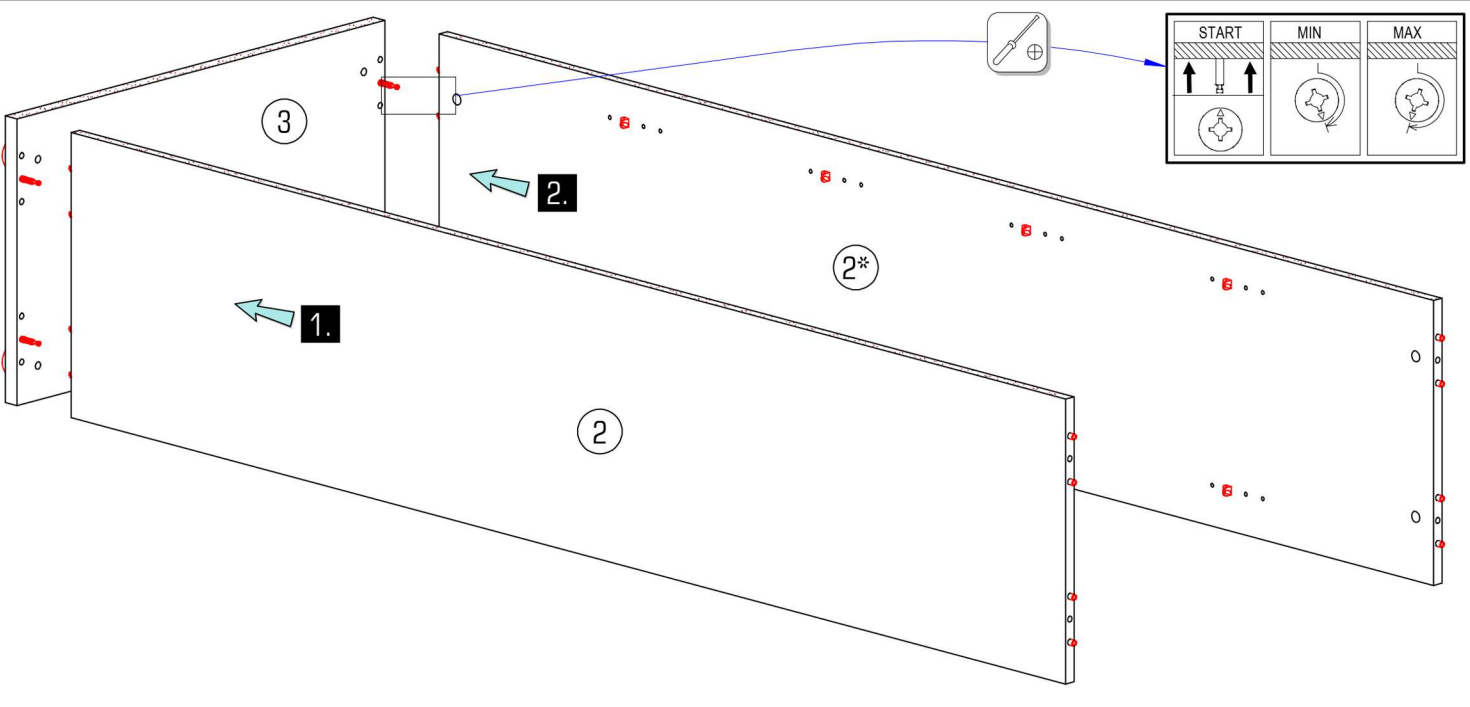
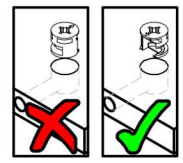
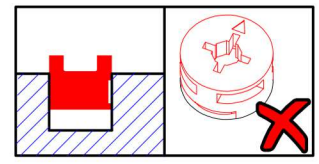
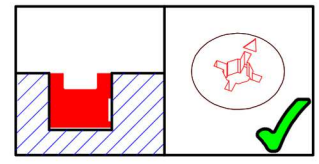
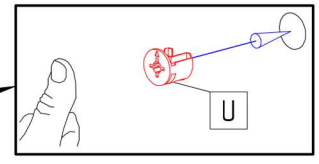
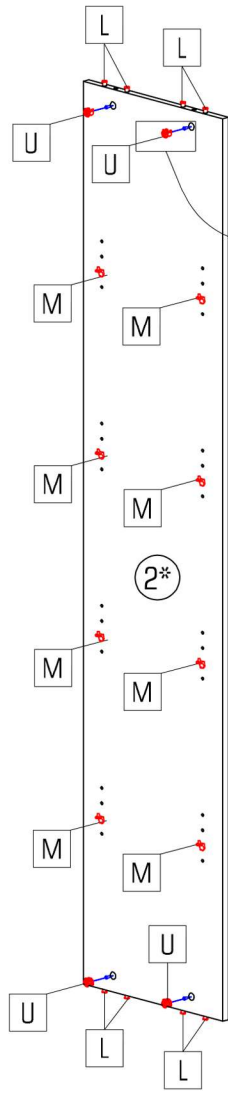
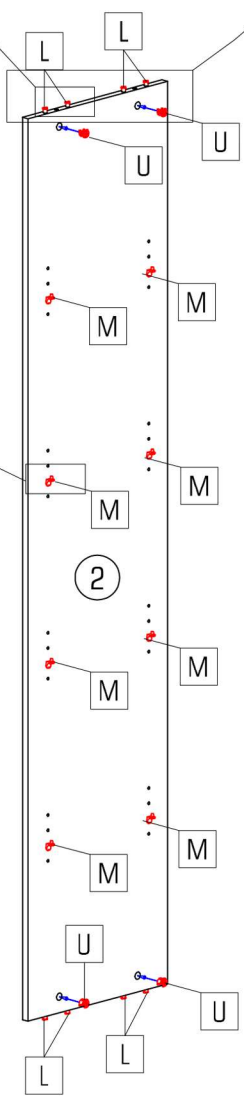
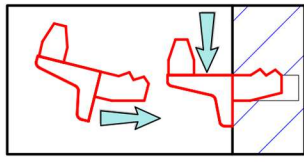
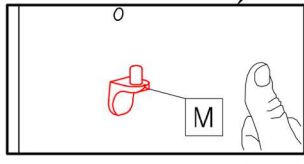
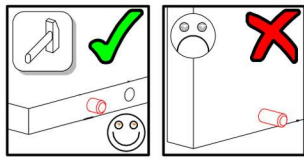
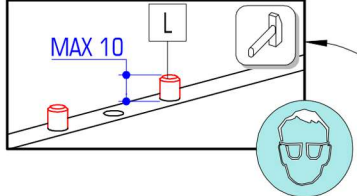
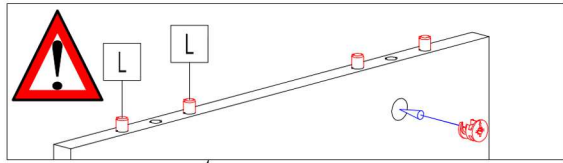

		
Ø8x30	Ø15x13	
L 16x	M 16x	U 8x

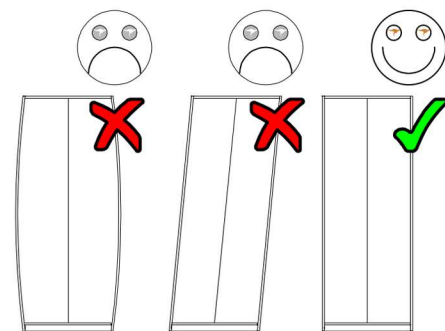
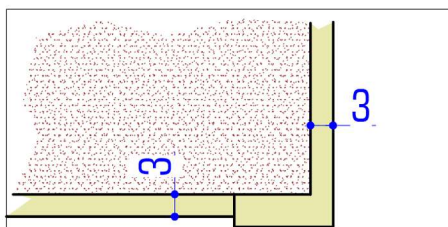
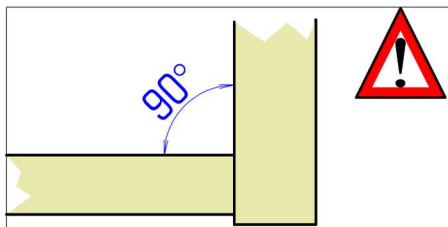
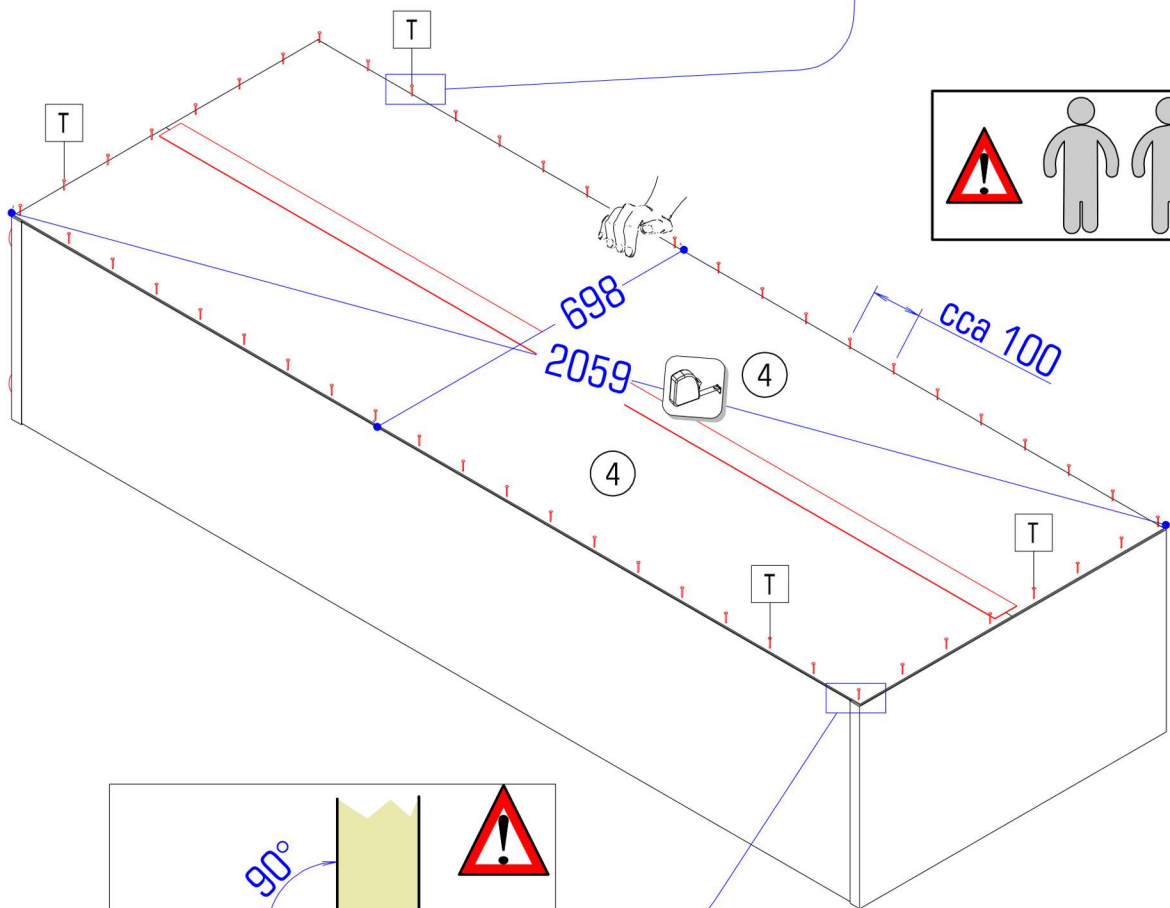
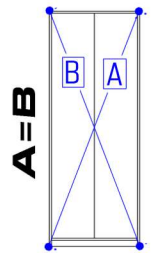
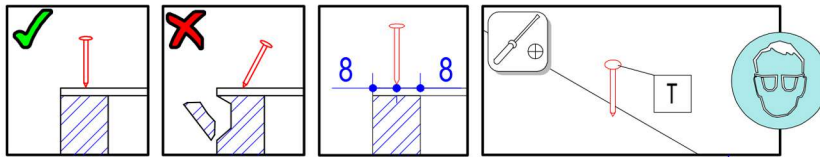
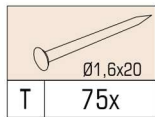
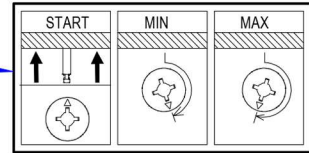
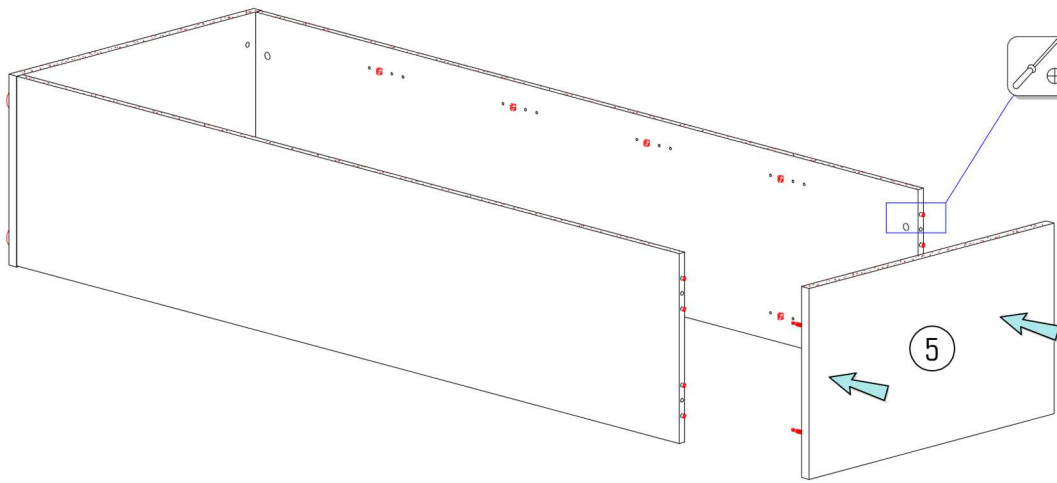

# 4/6 KLAUDIUS TYP1



			
B 1x	E 2x	K 1x	P 1x

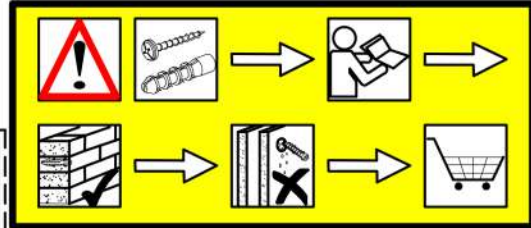

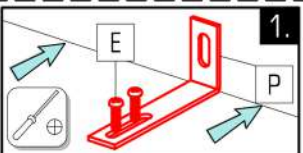
**1.** 

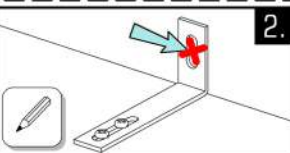
**2.** 

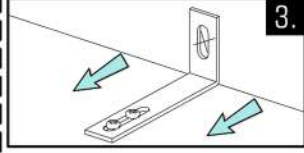
**3.** 

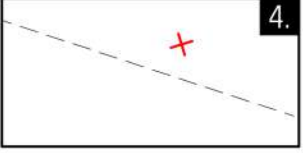
**4.** 

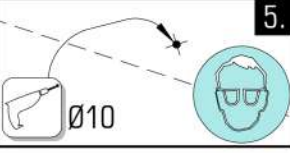
**5.** 

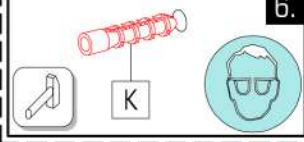
**6.** 

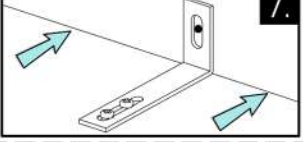
**7.** 

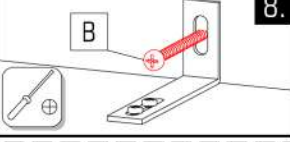
**8.** 

**Caution!** The wall must be examined before assembly. The included universal wall plugs are only suitable for using in firm masonry such as concrete block or brick. Do not use the wall plugs masonry such as hollow brick, lightweight block, surfaces such as gypsum plasterboard or other framing systems. If applicable, particular wall plugs must be used! These are available at a specialised store (hardware store). In case of non-compliance, the manufacturer/retailer or importer do not assume liability.

**Upozorenie!** Pevnosť steny sa musí pred montážou bezpodmienečne skontrolovať. Priložené univerzálne hmoždenky používajte jedine pre pevné murivo ako je betón/tehla. Hmoždenky sa nesmú používať v prípade ľahkého stavebního muriva, dutá tehla, Sádrokartónová doska, alebo iných konštrukcií rámu. U týchto stien je nutné použiť špeciálne hmoždenky! Tieto je možné dostať v špeciálnych predajniach so stavebným materiálom. Pri nedodržíaní pokynov nepreberajú výrobcovia/predajci a dodávateľa zodpovednosť za vzniknuté škody.

**Upozornění!** Před montáží je nutné zkontrolovat stav stěny. Přiložené univerzální hmoždinky jsou určeny pouze k použití pro pevné zdivo jako beton/cihly. Hmoždinky do zdi se nesmí používat u dutinová cihla, zdiva jako pórovitý stavební kámen, sádrokartónová deska nebo jiný měkký materiál. U těchto zdív jsou nutné použít speciální hmoždinky! Jsou k dostání v speciálních prodejnách se stavebním materiálem. Při nedodržení těchto pokynů výrobce/prodejce a dovozce neručí za způsobené škody.

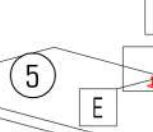
**5** 

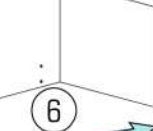
**6** 

**6** 

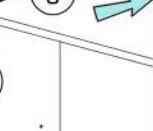
**2** 

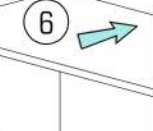
**6** 

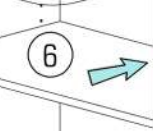
**6** 

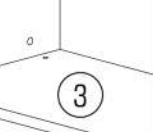
**3** 

**2\*** 

**5 kg** 

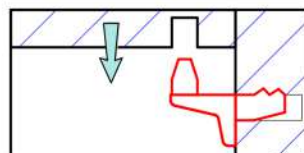
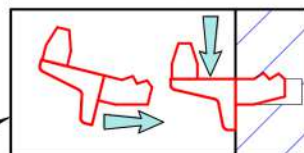
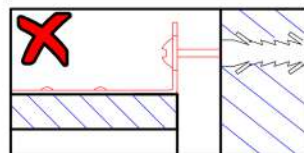
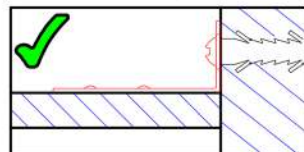
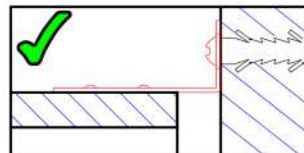
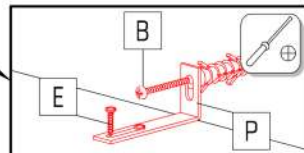

**Pažnja!** Prije montaže obavezno provjerite svojstvo zida. Priložene univerzalne tiple namijenjene su isključivo za masivne zidove od betona/opeke. Tiple za masivne zidove ne smiju se koristiti za zidove kao npr. supljina opeka laki sastavni elementi, gips-kartonske ploče ili drugi modularni načini gradnje. Za te zidove potrebne su eventualno specijalne tiple! Iste su dostupne u specijaliziranim trgovinama građevinskim materijalom. U slučaju nepridržavanja prethodno navedenih napomena, proizvođač/trgovac i uvoznik ne preuzimaju odgovornost!

**Achtung!** Die Wandbeschaffenheit ist vor der Montage unbedingt zu prüfen. Die beigelegten Universaldübel sind ausschließlich nur zur Verwendung für festes Mauerwerk wie Beton/Ziegel. Die Mauerdübel dürfen nicht bei Mauerwerk wie Hohlraumziegel, Leichtbausteinen, Gipskartonplatte oder anderer Rahmenbauweise verwendet werden. Bei diesen Mauerwerken sind gegebenenfalls Spezialdübel zu verwenden! Diese sind in einem Fachgeschäft erhältlich. Bei Nichteinhaltung wird seitens Produzenten/Handler und Importeur keine Haftung übernommen.

**Vigyázat!** Szerelés előtt a falfeleletet feltétlenül vizsgálja meg. A mellékelt univerzális tiplék kizárólag stabil falazathoz használható mint például beton/égla. A fali tiplék nem használható könnyű építőkövekhez, üreg téglák, gipszkarton lapokhoz vagy más fávázás építményekhez. Ezekhez a falfeleletekhez csak speciális tiplék használhatóak, melyek szaküzletekben (barkácsáruházakban) beszerezhetőek. Fentiek figyelmen kívül hagyása esetén a gyártó/kereskedő vagy forgalmazó nem vállal felelősséget.

**Prudență!** Zidul trebuie examinat înainte de asamblare prizele de perete sunt adecvate numai pentru utilizarea în zidărie formă, cum ar fi betonul bloc sau cărămidă. Nu folosiți zidăria zidurilor de perete, cum ar fi cărămidă goală, blocul ușor, suprafețe cum ar fi gips-carton sau altă încadrare sisteme. Dacă este cazul, trebuie folosite anumite prize de perete! Acestea sunt disponibile la un magazin specializat (magazin de hardware). În caz de nerespectare, producătorul / vânzătorul cu amănuntul sau importatorul nu își asumă răspunderea.

**Uwaga!** Ścianę należy sprawdzić przed montażem. Dołączone uniwersalne kołki rozporowe są odpowiednie tylko do stosowania w mocnych murach, takich jak beton lub cegła. Nie robć za pomocą kołków rozporowych murowanych, takich jak pustak, lekka kostka, powierzchnie takie jak płyty gipsowo-kartonowe lub inne systemy ram. Jeśli dotyczy, muszą to być określone kołki rozporowe być użytym! Są one dostępne w specjalistycznym sklepie niezgodności, producent / sprzedawca lub importer nie ponoszą odpowiedzialności.

**Pozor!** Pred montažu proverite stanje stene. Priloženi univerzalni mozniki so izključno samo za uporabo na čvrstem zidovju, kot sta beton in opeka. Stenski mozniki se ne smejo uporabljati pri zidovju kot so votlino opeke, zidaki za lahko gradnjo, mavčne plošče ali druge okvirne gradnje. Pri teh zidovjih morate v danih primerih uporabljati posebne moznike. Ti so na voljo v specializiranih trgovinah (trgovinah z gradbenim materialom) Pri upoštevanju se s strani proizvajalca/trgovca in uvoznika ne prevzame jamstvo.

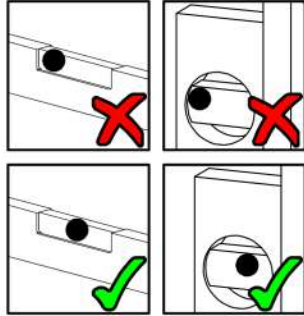

**RO AVERTISMENT**  
**EN WARNING**  
**SK VÝSTRAHA**  
**CZ VAROVÁNÍ**  
**HR UPOZORENIE**  
**DE WARNUNG**  
**HU FIGYELEM**  
**SE VARNING**  
**SI OPOZORILO**  
**PL OSTRZEŻENIE**

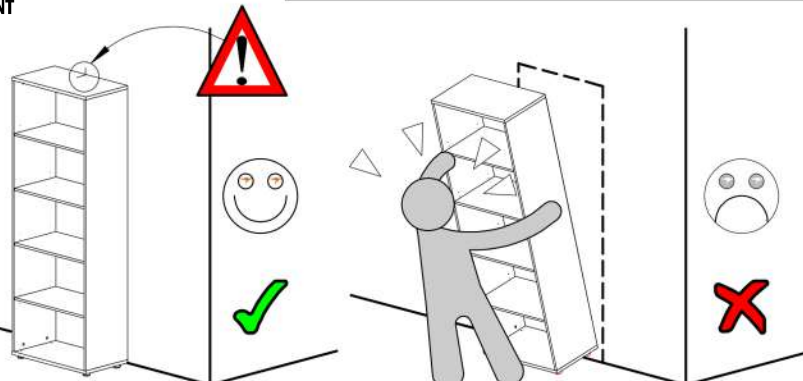

# 6/6 KLAUDIUS TYP 1



F

8x

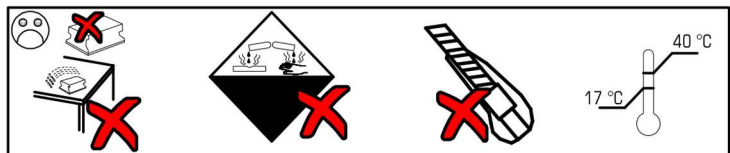
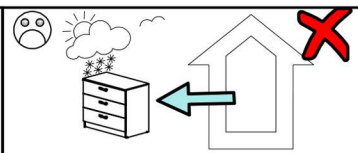
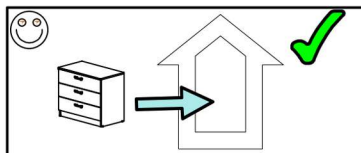
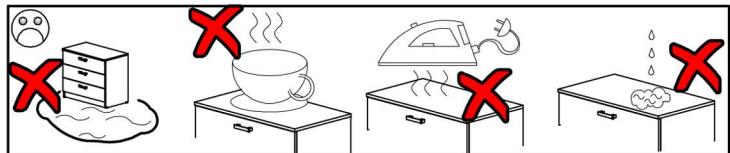
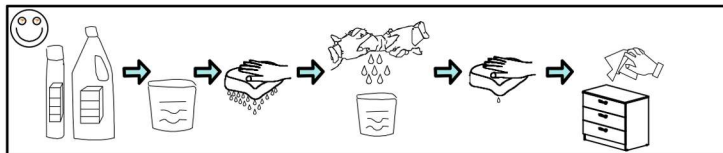
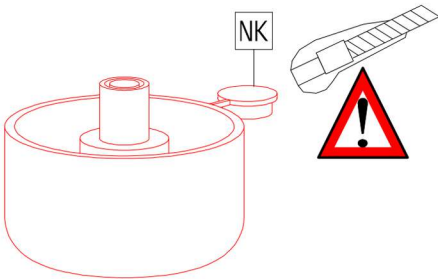
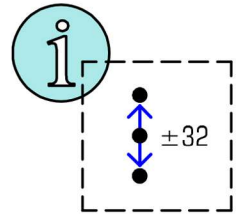
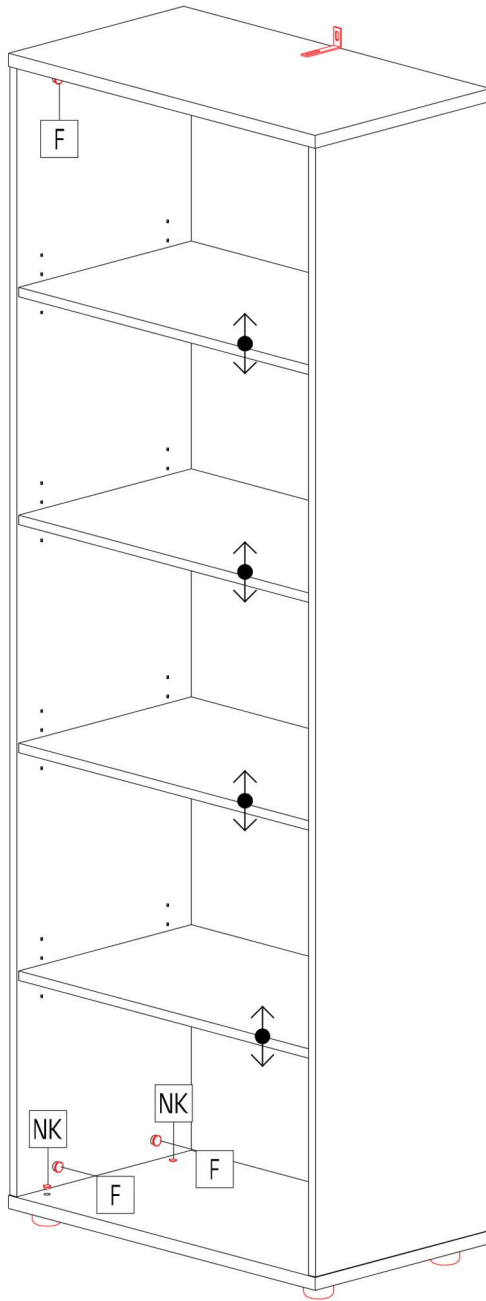

# KLAUDIUS TYP2

Art.-Nr.

394 622  
394 614

700  
1964  
400  
[mm]

1/7  
v0  
17-2024

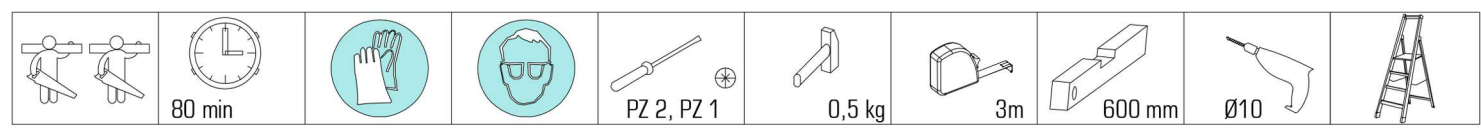

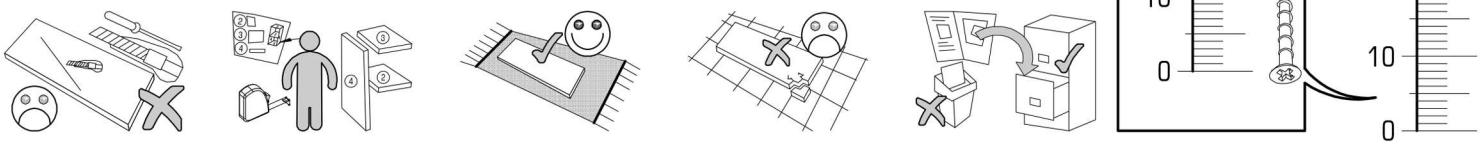
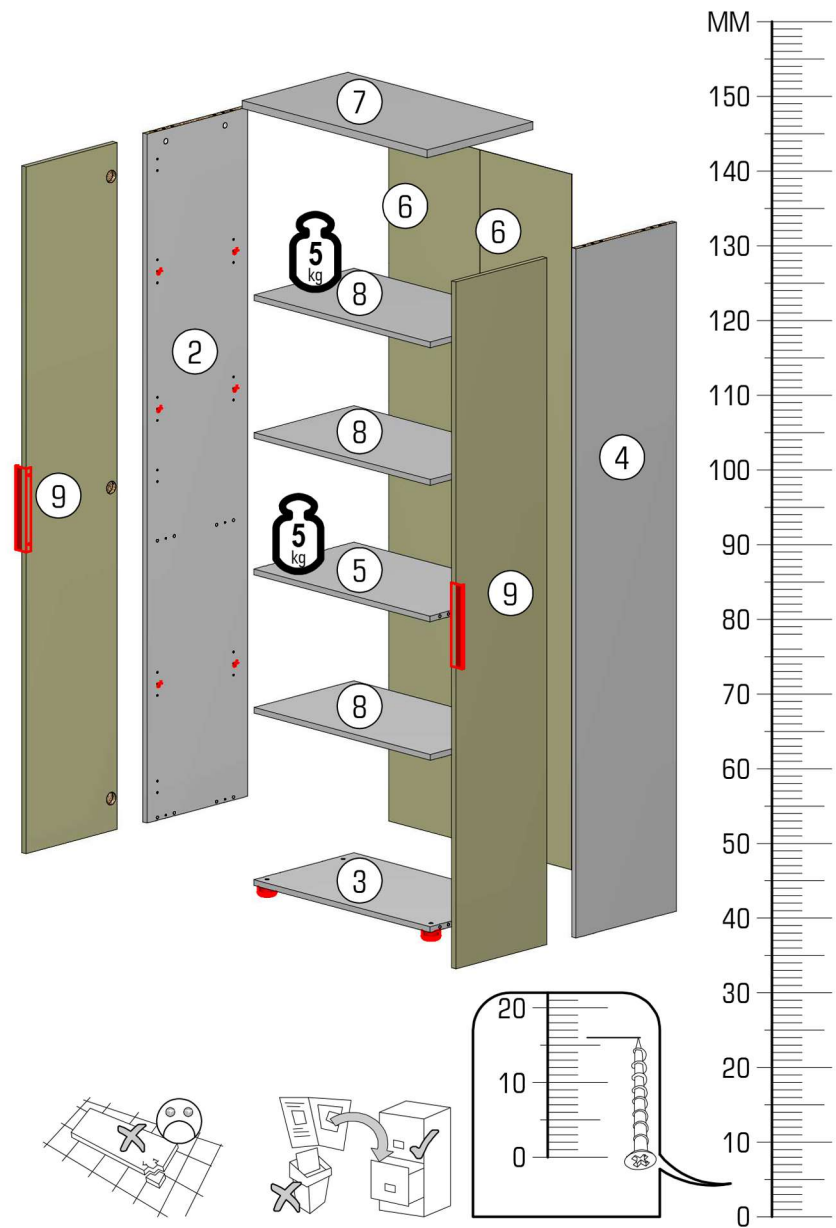
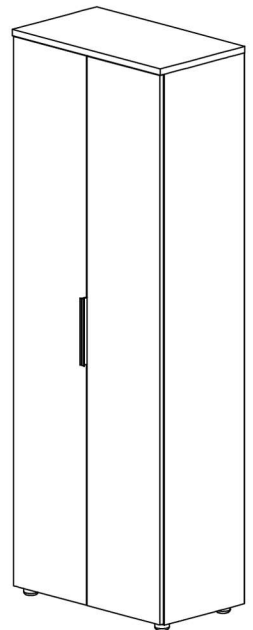

ID	ID			
21100	②	1914*380*16	1x	1/3
21101	③	666*379*16	1x	2/3
21102	④	1914*380*16	1x	1/3
21103	⑤	666*379*16	1x	2/3
21086	⑥	346*1932*3	2x	1/3
21087	⑦	700*400*22	1x	2/3
21104	⑧	666*378*16	3x	2/3
21105	⑨	344*1908*16	2x	3/3

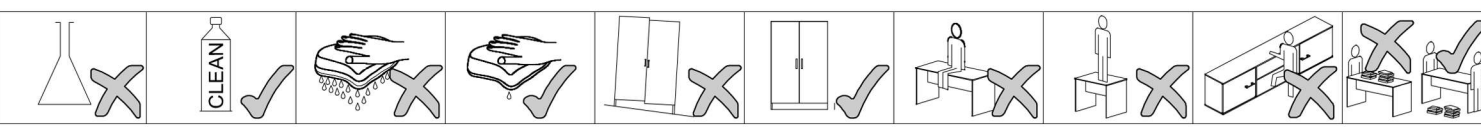

8402.03		Ø8	22256.00		Ø5,0x70	22234.00		Ø3,0x12	22243.00		Ø3,5x15	22244.01		Ø3,5x16	34956.00		22800.01		4	21102.00		Ø1,6x20	24101.00		Ø10	
A	2x		B	1x		C	4x		D	12x		E	2x		F	8x	G	1x		H	75x		K	1x		
27000.00		Ø8x30	8501.00			30082.01		Ø50 v=27	31103.00			32246.00		L=230	70013.01		Ø15x13	70027.01			36002.07			36002.07		
L	24x		M	12x		N	4x		P	1x		Q	2x		U	12x		V	12x		X	6x		Y	6x	



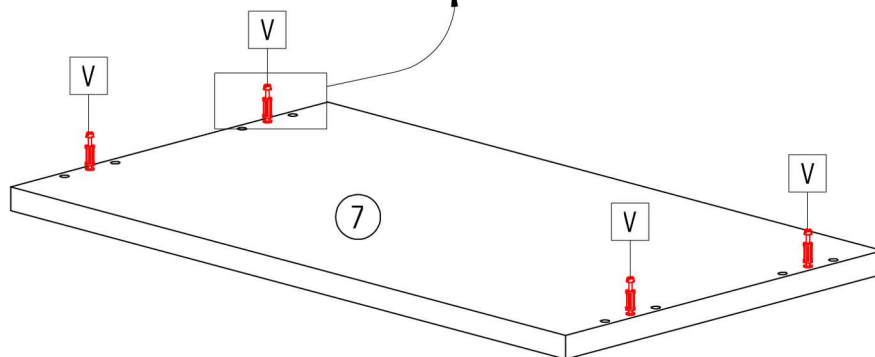
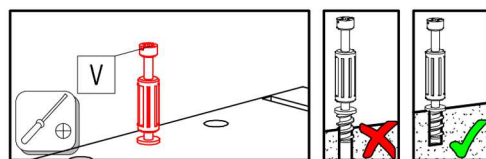
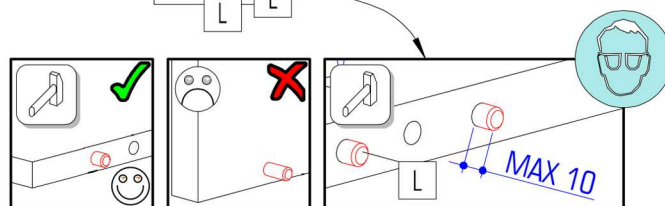
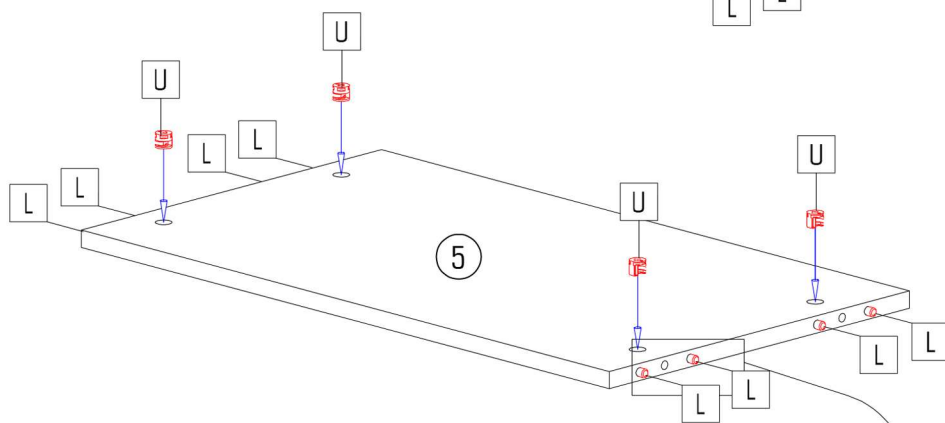
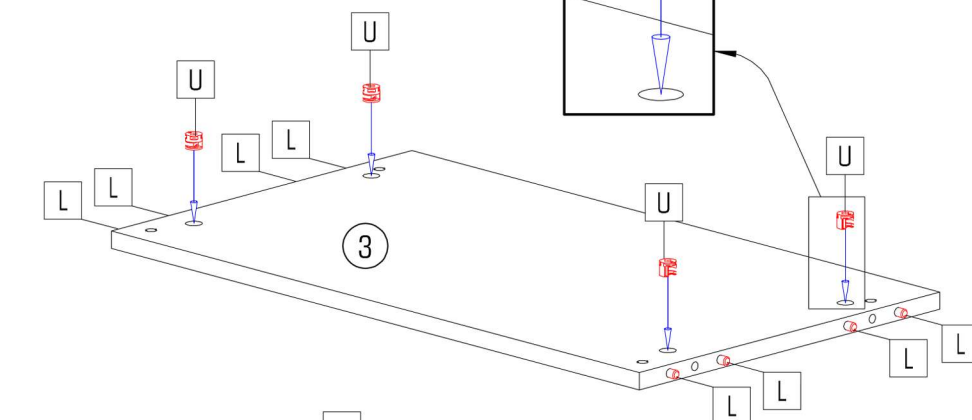
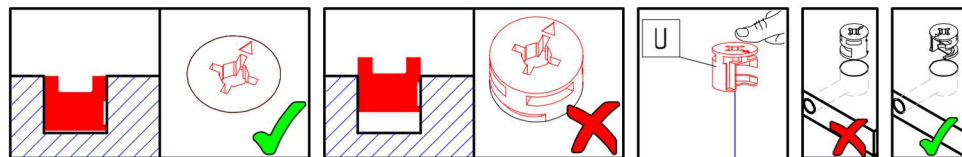
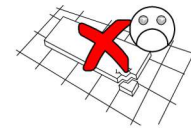

# 2/7 KLAUDIUS TYP2

	Ø8x30		Ø15x13	
L	16x	U	8x	V
				4x



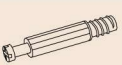
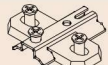

				
L 8x	M 12x	U 4x	V 8x	Y 6x

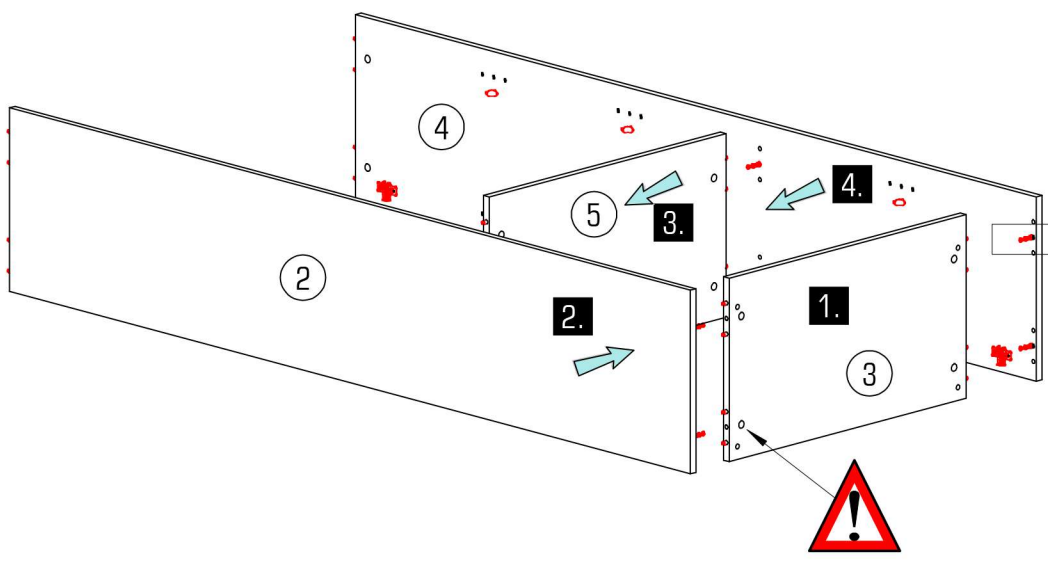
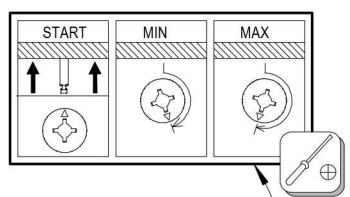
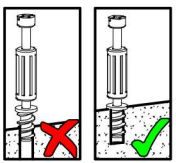
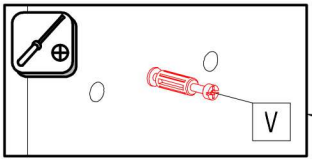
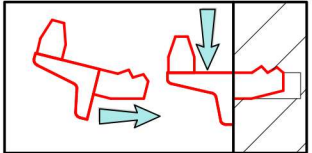
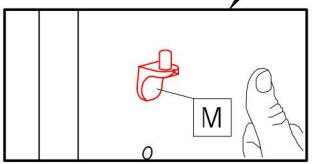
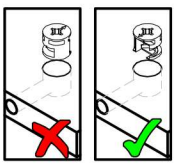
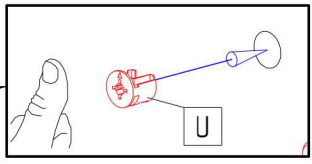
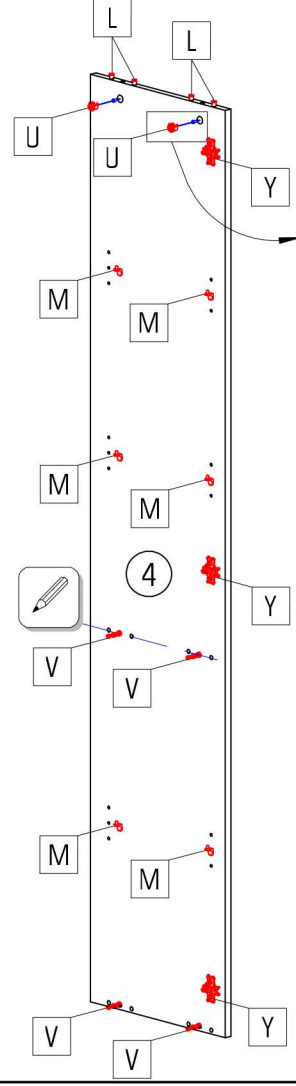
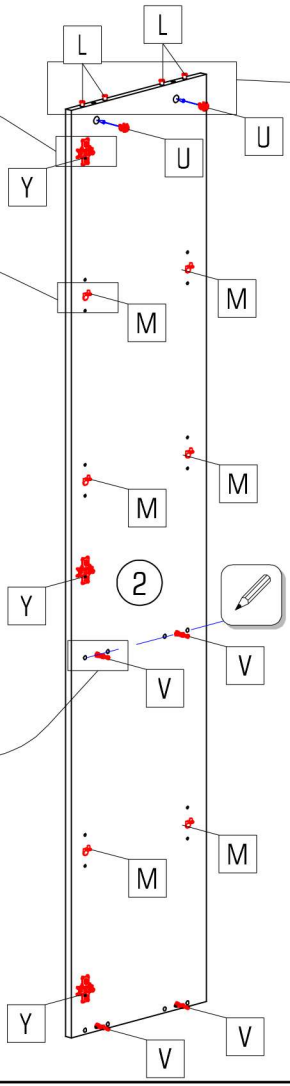
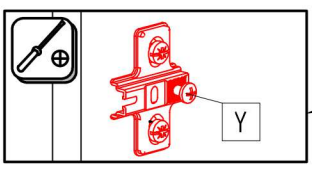
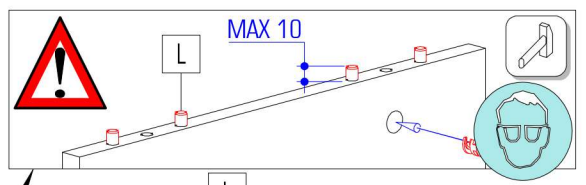



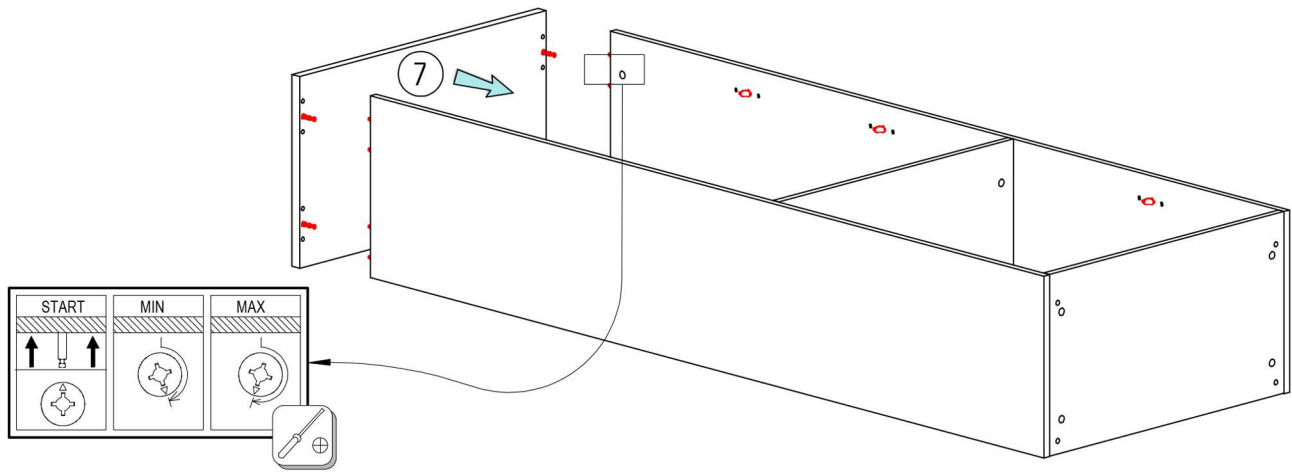

# 4/7 KLAUDIUS TYP2

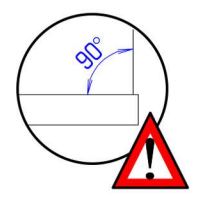
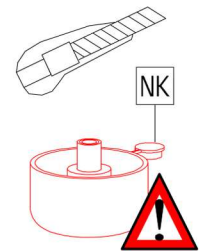
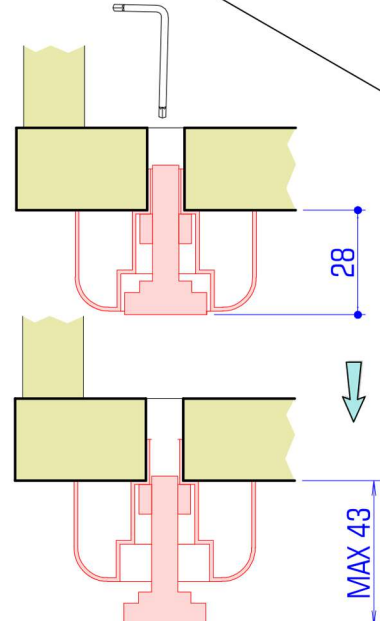
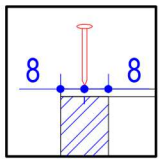
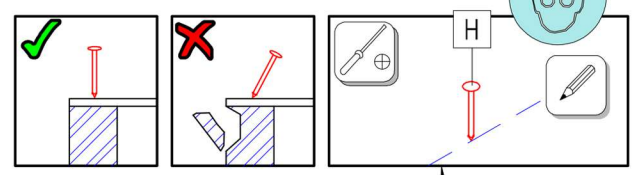
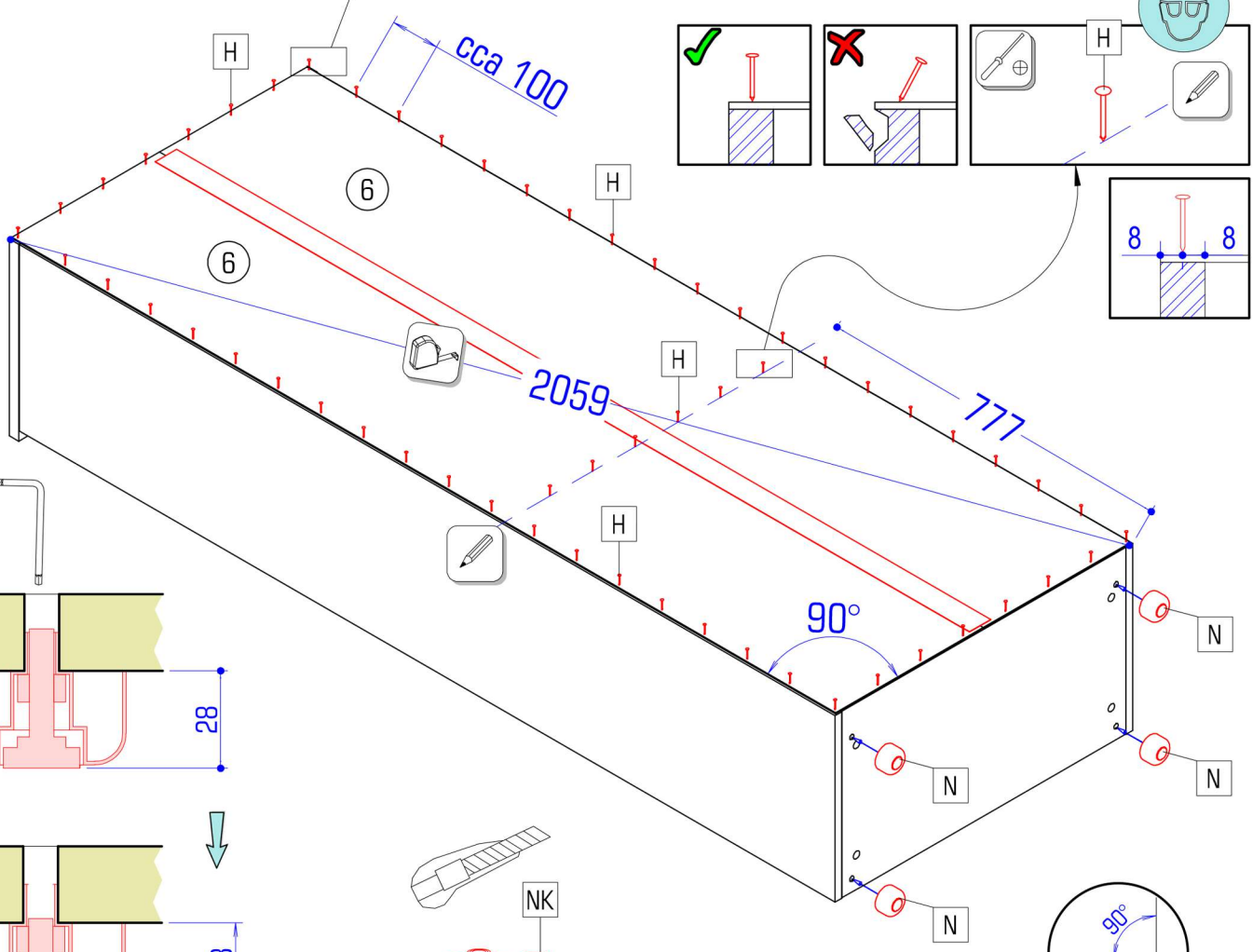
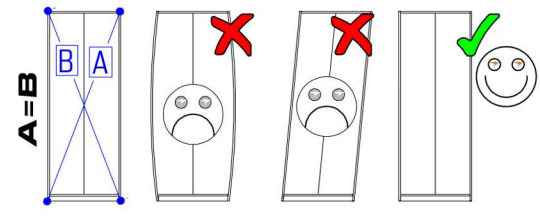
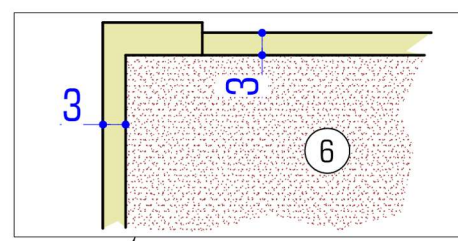
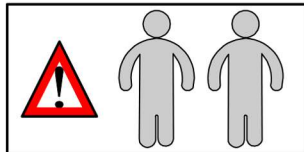

Ø1,6x20	Ø50 v=27
H 75x	N 4x



			
Ø5,0x50	Ø3,5x16	Ø10	
B 1x	E 2x	K 1x	P 1x

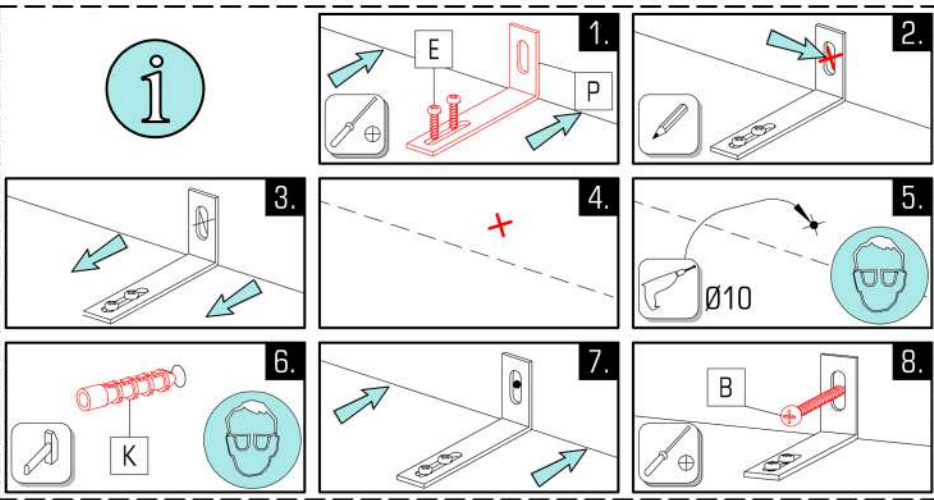

**1.** Insert screw E into the wall plug P.

**2.** Push the wall plug P into the wall.

**3.** Push the shelf bracket B into the wall plug P.

**4.** Check the verticality of the wall plug P.

**5.** Drill a hole with diameter Ø10 into the wall.

**6.** Insert screw K into the wall plug P.

**7.** Push the shelf bracket B into the wall plug P.

**8.** Tighten the screw K to secure the shelf bracket B.

**Prudență!** Zidul trebuie examinat înainte de asamblare prizele de perete sunt adecvatenumai pentru utilizarea în zidărie fermă, cum ar fi betonul bloc sau cărămidă. Nu folosiți zidăria zidurilor de perete, cum ar fi cărămidă goală, blocul ușor, suprafețe cum ar fi gips-carton sau altă încadrare sisteme. Dacă este cazul, trebuie folosite anume prize de perete! Acestea sunt disponibile în un magazin specializat (magazin de hardware) . În caz de nerespectare, producătorul / vânzătorul cu amănuntul sau importatorul nu își asumă răspunderea.

**Caution!** The wall must be examined before assembly The included universal wall plugs are only suitable for using in firm masonry such as concrete block or brick. Do not using the wall plugs masonry such as hollow brick, lightweight block, surfaces such as gypsum plasterboard or other framing systems. If applicable, particular wall plugs must be used! These are available at a specialised store (hardware store).In case of non-compliance, the manufacturer/retailer or importer do not assume liability.

**Upozornenie!** Pevnosť steny sa musí pred montážou bezpodmienečne skontrolovať. Priložené univerzálne hmoždenky používajte jedine pre pevné múrivo ako je betón/tehla. Hmoždenky sa nesmú používať v prípade ľahkého stavebného múriva, dutá tehla, Sádrokartónová doska, alebo iných konštrukcií rámu. U týchto stien je nutné použiť špeciálne hmoždenky! Tieto je možné dostať v špeciálnych predajniach so stavebným materiálom. Pri nedodržiati pokynov nepreberajú výrobcovia/predajci a dodávateľa zodpovednosť za vzniknuté škody.

**Upozornění!** Před montáží je nutné zkontrolovat stav stěny. Priložené univerzální hmoždinky jsou určeny pouze k použití pro pevné zdivo jako beton/cihly. Hmoždinky do zdi se nesmí používat u dutinová cihla, zdívka jako porovity stavební kámen, sádrokartónová deska nebo jiný měkký materiál. U těchto zdív jsou nutné použít speciální hmoždinky! Jsou k dostání v speciálních prodejních se stavebním materiálem. Při nedodržení těchto pokynů výrobce/prodeje a dovozce neručí za způsobené škody.

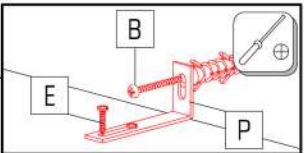
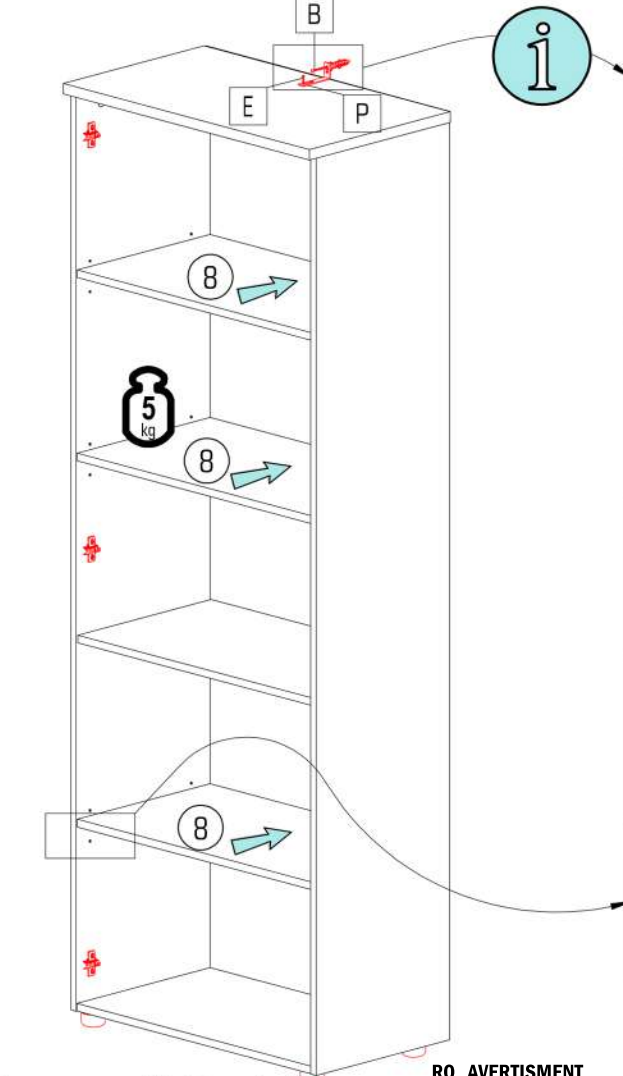

**Paznja!** Prije montaže obavezno provjerite svojstvo zida. Priložene univerzalne tiplje namijenjene su isključivo za masivne zidove od betona/opeke. Tiplje za masivne zidove ne smiju se koristiti za zidove kao npr šupljina opeka laki sastavni elementi, gips-kartonske ploče ili drugi modularni načini gradnje. Za te zidove potrebne su eventualno specijalne tiplje! Iste su dostupne u specijaliziranim trgovinama građevinskim materijalom. U slučaju nepridržavanja prethodno navedenih napomena, proizvođač/trgovac i uvoznik ne preuzimaju odgovornost!

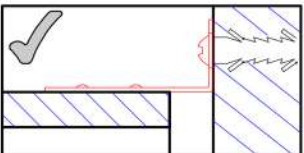

**Achtung!** Die Wandbeschaffenheit ist vor der Montage unbedingt zu prüfen. Die beigelegten Universaldübel sind ausschließlich nur zur Verwendung für festes Mauerwerk wie Beton/Ziegel. Die Mauerdübel dürfen nicht bei Mauerwerk wie Hohlraumziegel, Leichtbausteinen, Gipskartonplatte oder anderer Rahmenbauweise verwendet werden. Bei diesen Mauerwerken sind gegebenenfalls Spezialdübel zu verwenden! Diese sind in einem Fachgeschäft erhältlich. Bei Nichteinhaltung wird seitens Produzenten/Händler und Importeur keine Haftung übernommen.

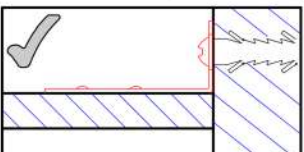

**Vigyázat!** Szerelés előtt a falfelületet feltétlenül vizsgálja meg. A mellékelt univerzális tiplje kizárólag stabil falazathoz használható mint például beton/tégla. A fali tiplje nem használható könnyű építőkövekhez, üreg tégla, gipszkarton lapokhoz vagy más fázavás építményekhez. Ezekhez a falfelületekhez csak speciális tiplje használhatóak, melyek szaküzletekben (barkácsárúházakban) beszerezhetőek. Fentiek figyelmen kívül hagyása esetén a gyártó/kereskedő vagy forgalmazó nem vállal felelősséget.

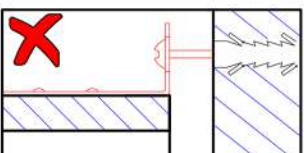

**OBS!** Väggen sammansättning ska absolut kontrolleras innan montering. De bifogade pluggarna får endast användas för stabila och fasta väggar, som tex. betong/tegel. De får absolut inte användas för kavitet tegel, väggar ur fonolit, gipskivor eller dylikt. För dessa väggar måste det användas speciella pluggar, som finns att köpa i specialiserad handel (byggmarknad). Varken tillverkare, handlare eller importör övertar ansvar, om dessa anvisningar inte följs.

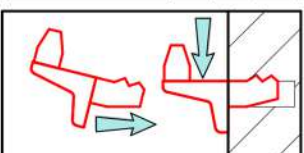

**Pozor!** Pred montažo proverite stanje stene. Priloženi univerzalni mozniki so izključno samo za uporabo na čvrstem zidovju, kot sta beton in opeka. Stenski mozniki se ne smejo uporabljati pri zidovju kot so votline opeke, zidaki za lahko gradnjo, mavčne plošče ali druge okvirne gradnje. Pri teh zidovjih morate v danih primerih uporabljati posebne moznike. Ti so na voljo v specializiranih trgovinah (trgovinah z gradbenim materialom) Pri upoštevanju se s strani proizvajalca/trgovca in uvoznika ne prevzame jamstvo.

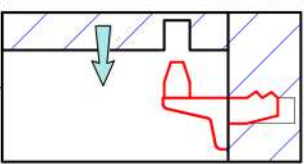



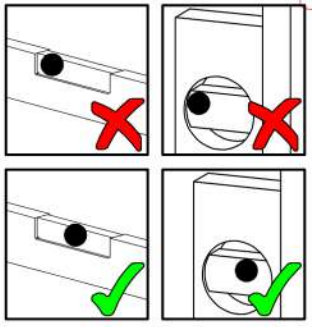

**Uwaga!** Ścianę należy sprawdzić przed montażem. Dołączone uniwersalne kołki rozporowe są odpowiednie tylko do stosowania w mocnych murach, takich jak beton lub cegła. Nie rób z pomocą kołków rozporowych murowanych, takich jak pustak, lekka kostka, powierzchnie takie jak płyty gipsowo-kartonowe lub inne systemy ram. Jeśli dotyczy, muszą to być określone kołki rozporowe być użytym! Są one dostępne w specjalistycznym sklepie niezgodność, producent / sprzedawca lub importer nie ponoszą odpowiedzialności.

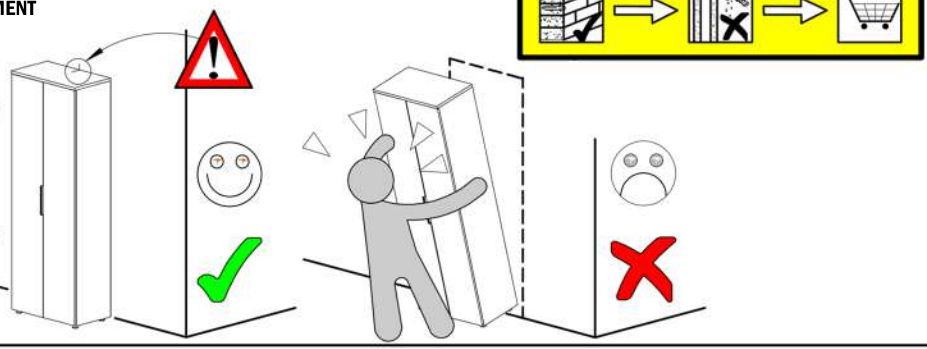
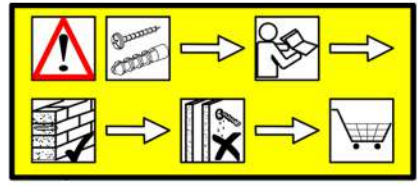



**RO AVERTISMENT**  
 EN WARNING  
 SK VÝSTRAHA  
 CZ VAROVÁNÍ  
 HR UPOZORENIE  
 DE WARNUNG  
 HU FIGYELEM  
 SE VARNING  
 SI OPOZORILO  
 PL OSTRZEŻENIE



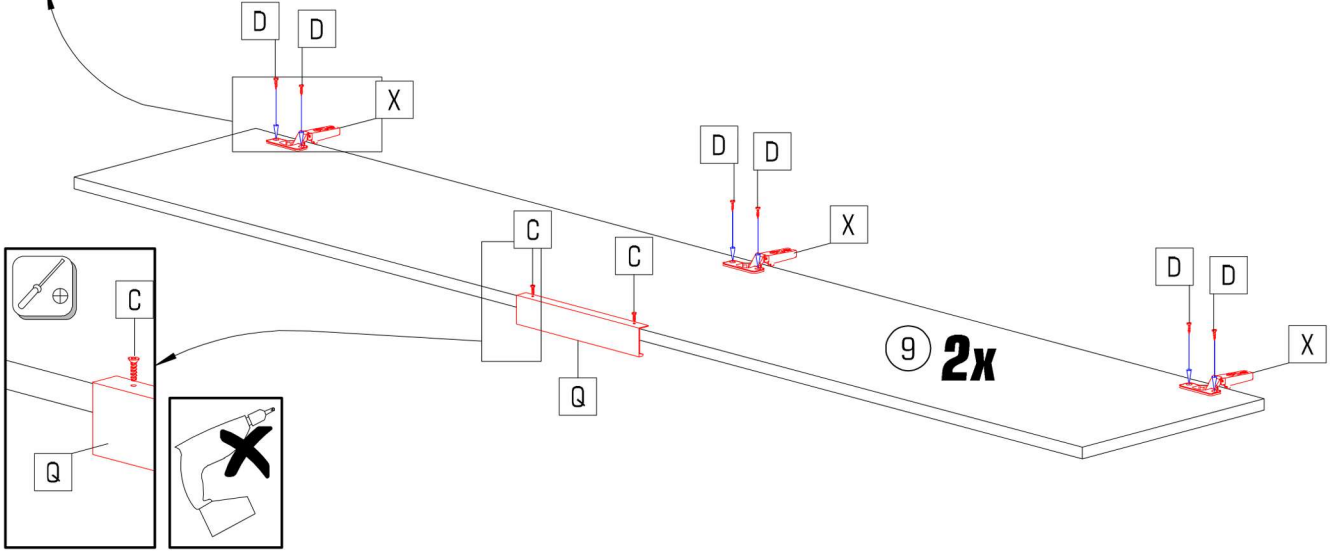
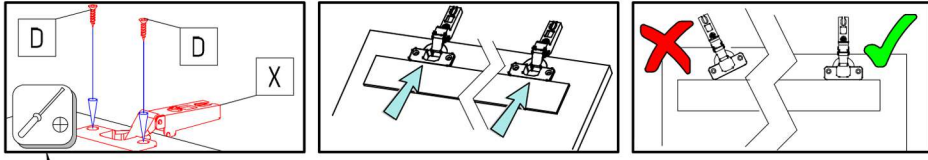

			
Ø3,0x12	Ø3,5x15	L=230	
C 4x	D 12x	Q 2x	X 6x

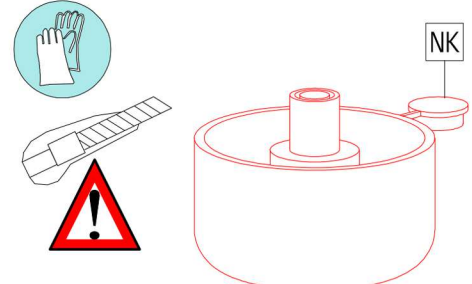
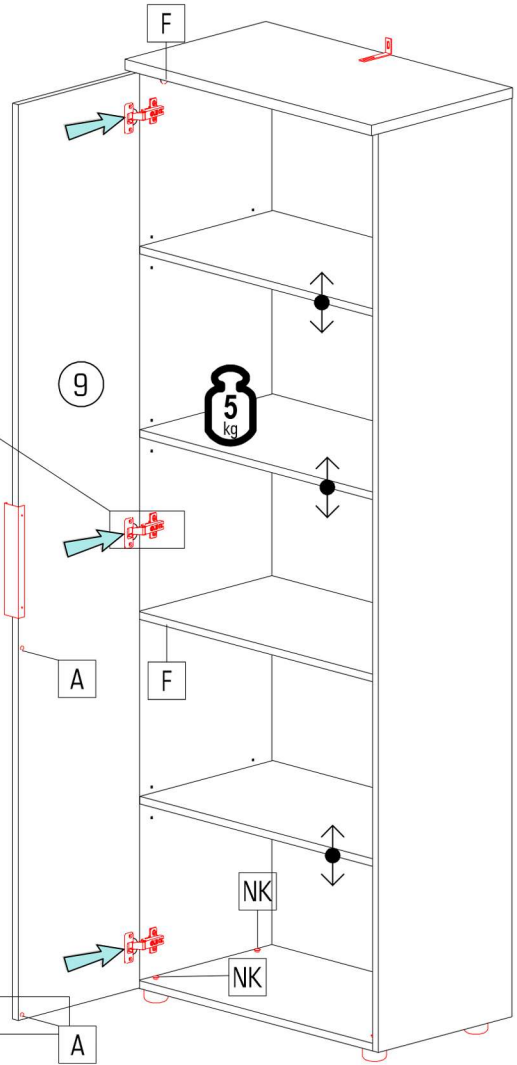
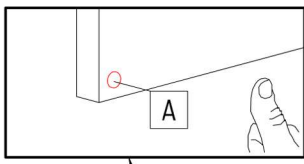
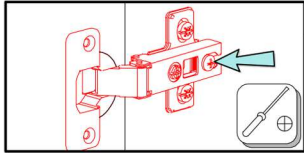
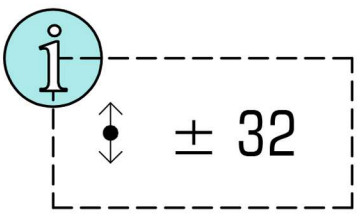

	
Ø8	
A 1x	F 8x

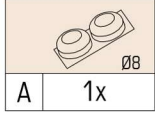



A 1x

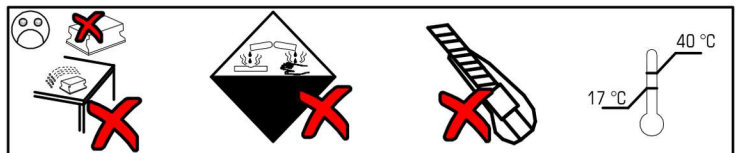
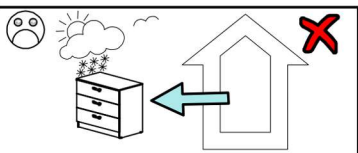
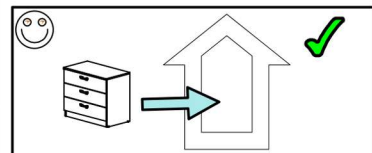
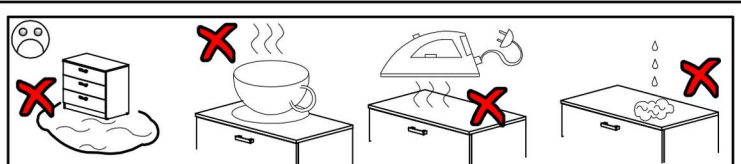
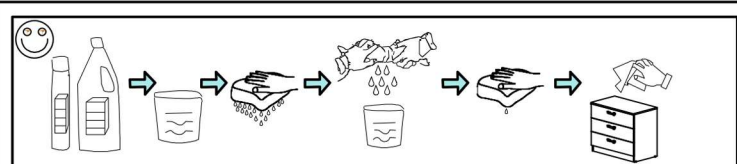
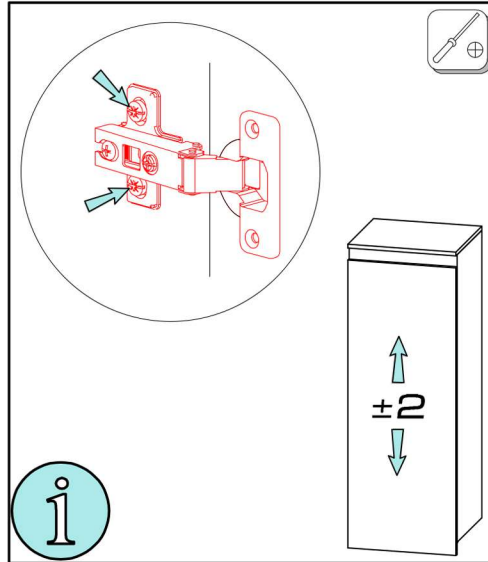
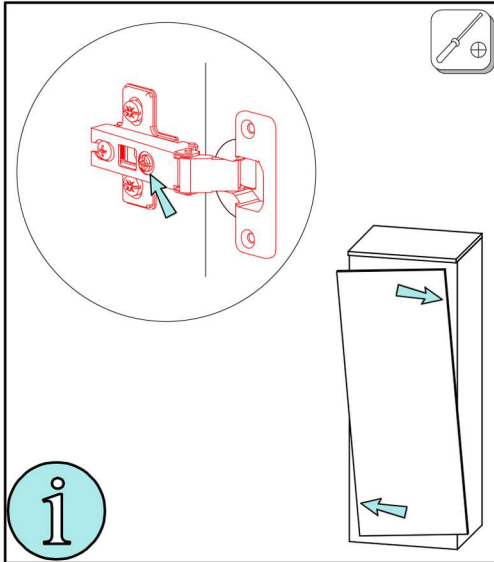
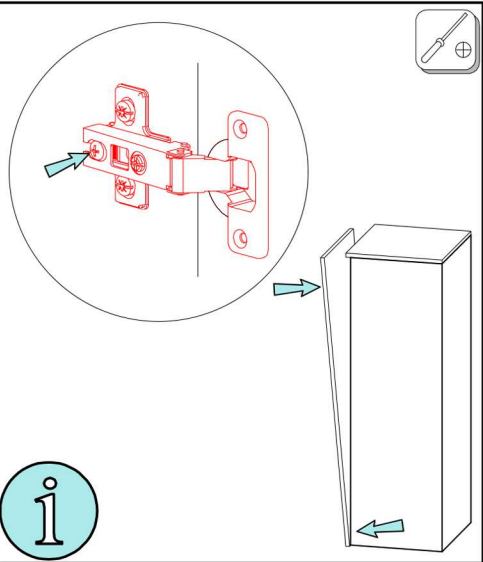
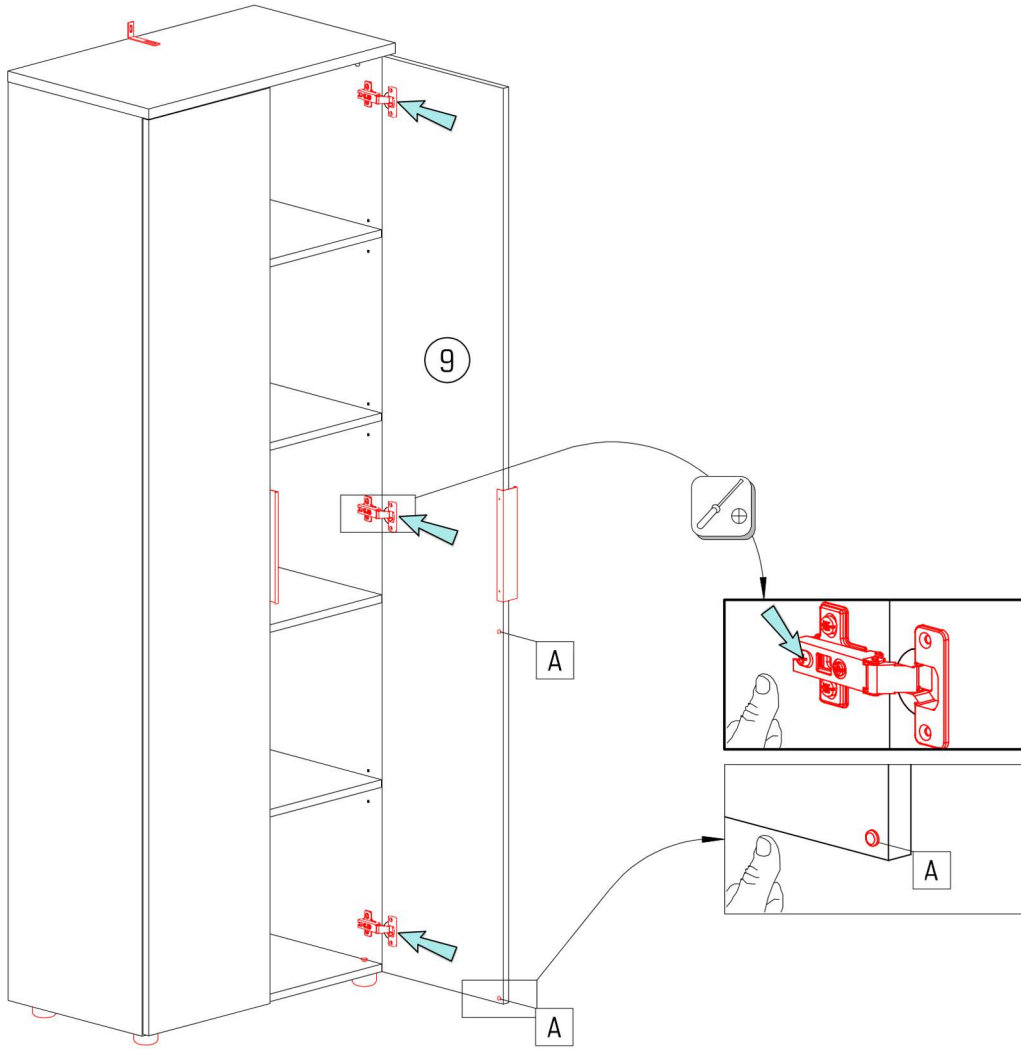



# 2/8 KLAUDIUS TYP 3

E 2x	L 8x	P 1x	U 4x	V 4x

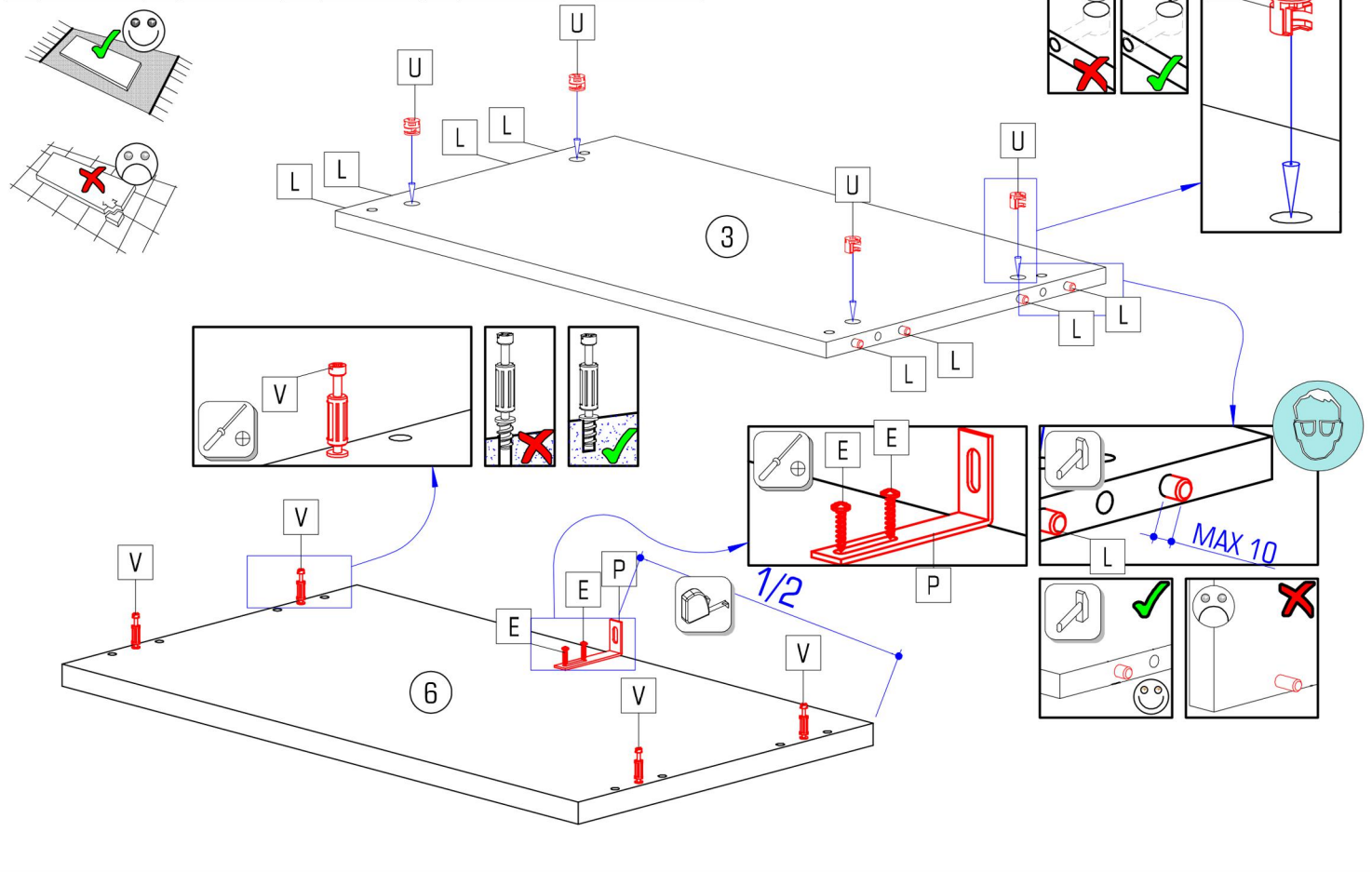

D 8x	H 4x	Q 2x	X 4x

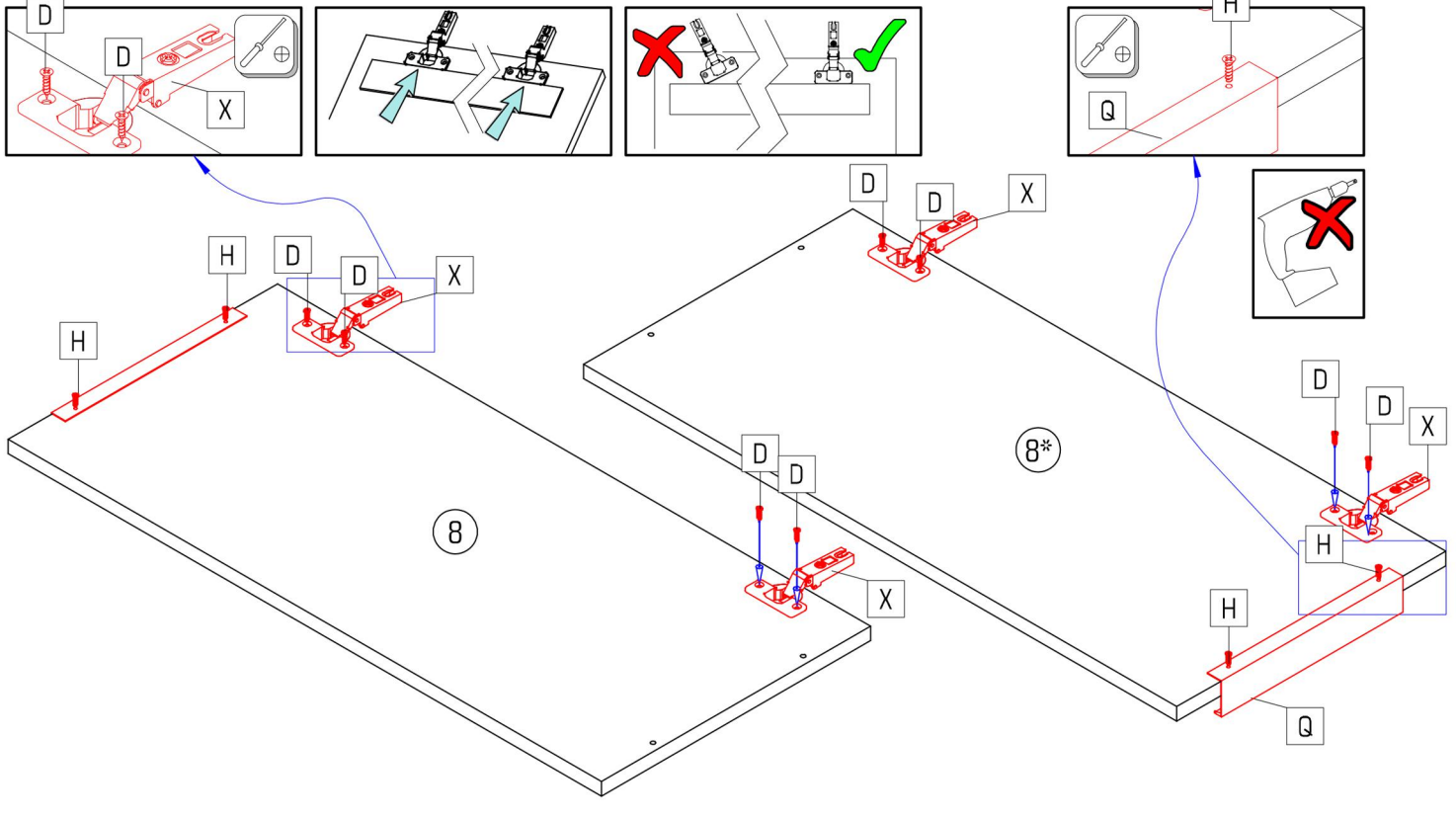

# KLAUDIUS TYP 3 3/8

C 2x	D 4x	L 8x	M 4x	R 8x	U 4x	V 4x	Y 4x

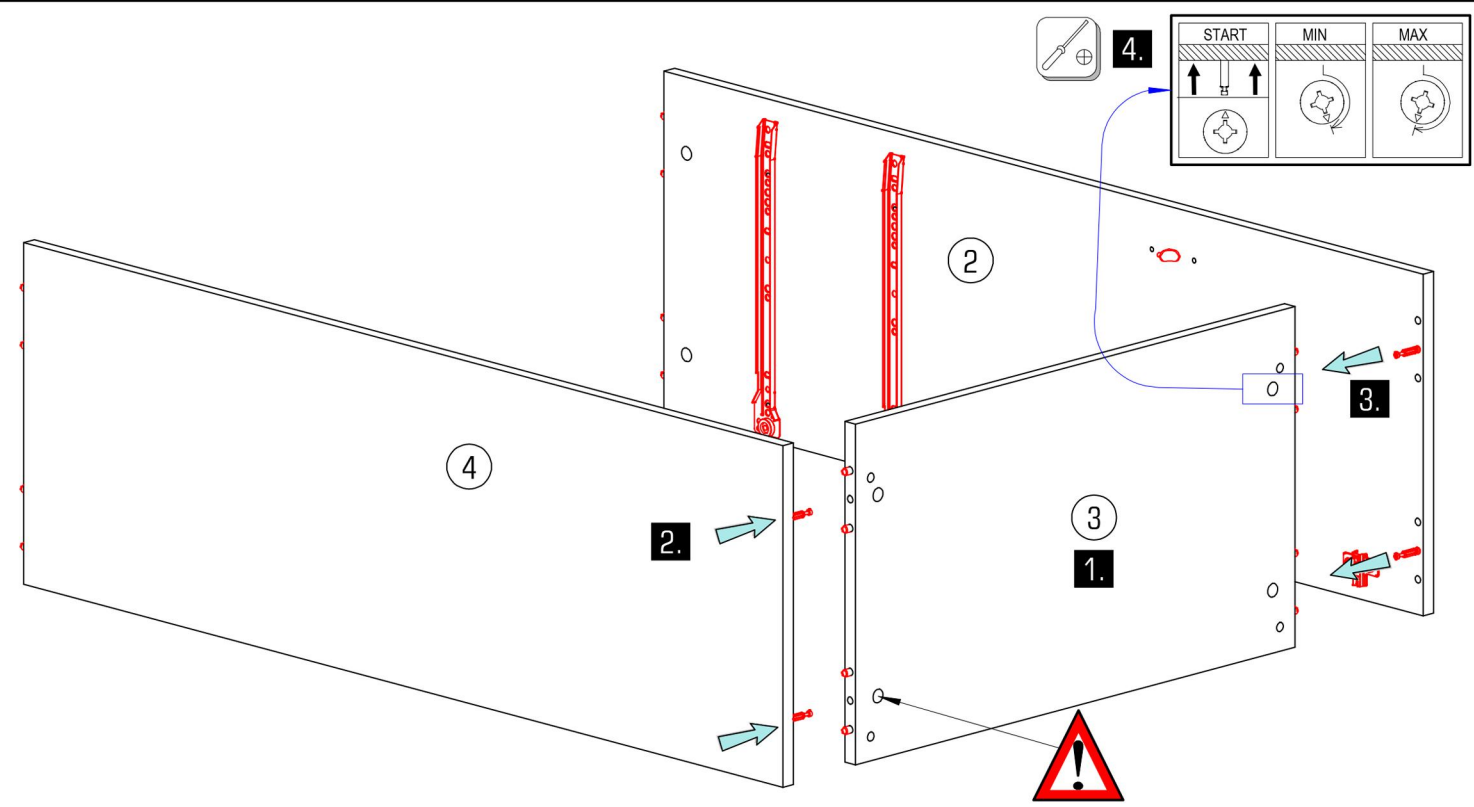
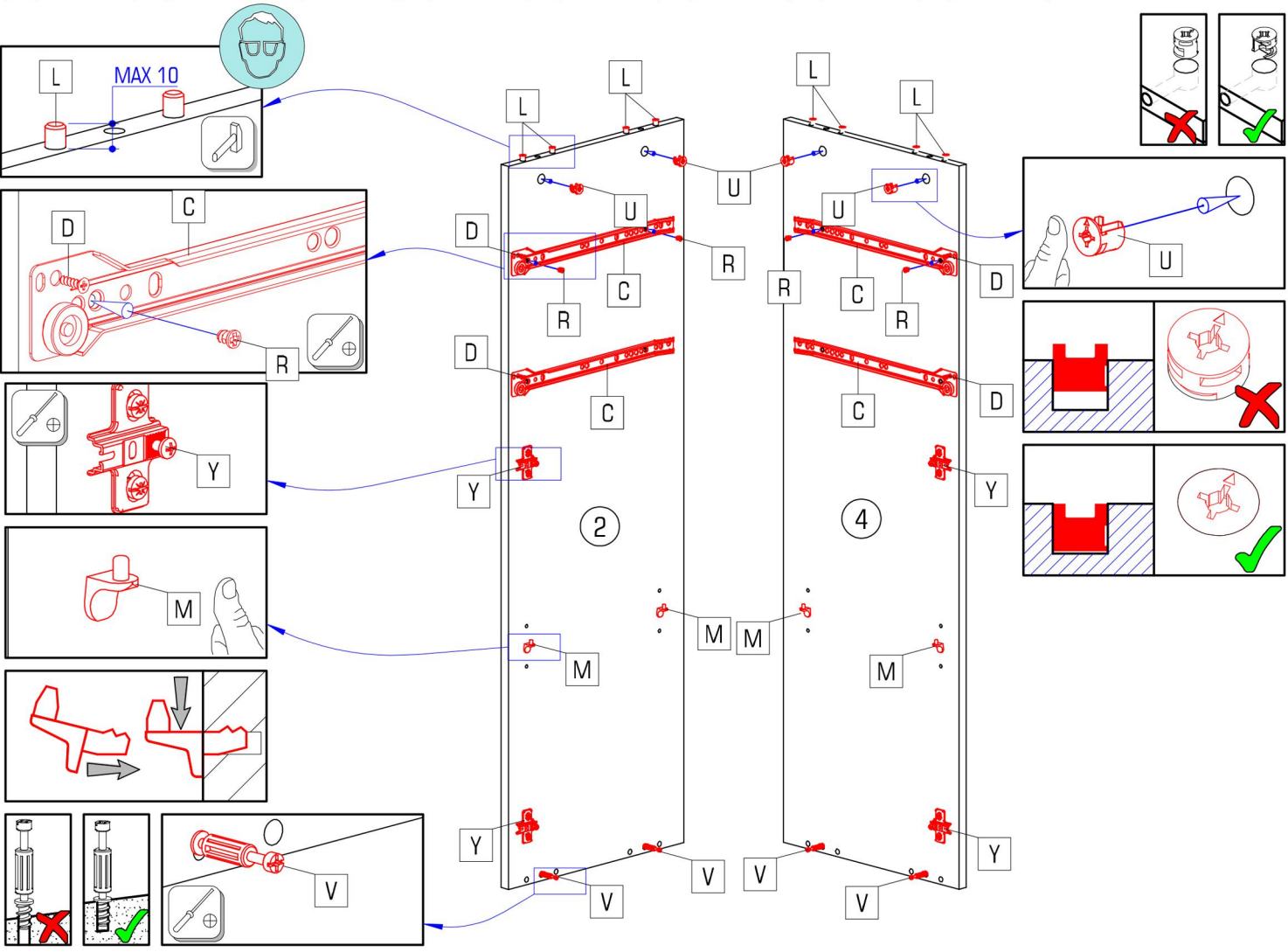



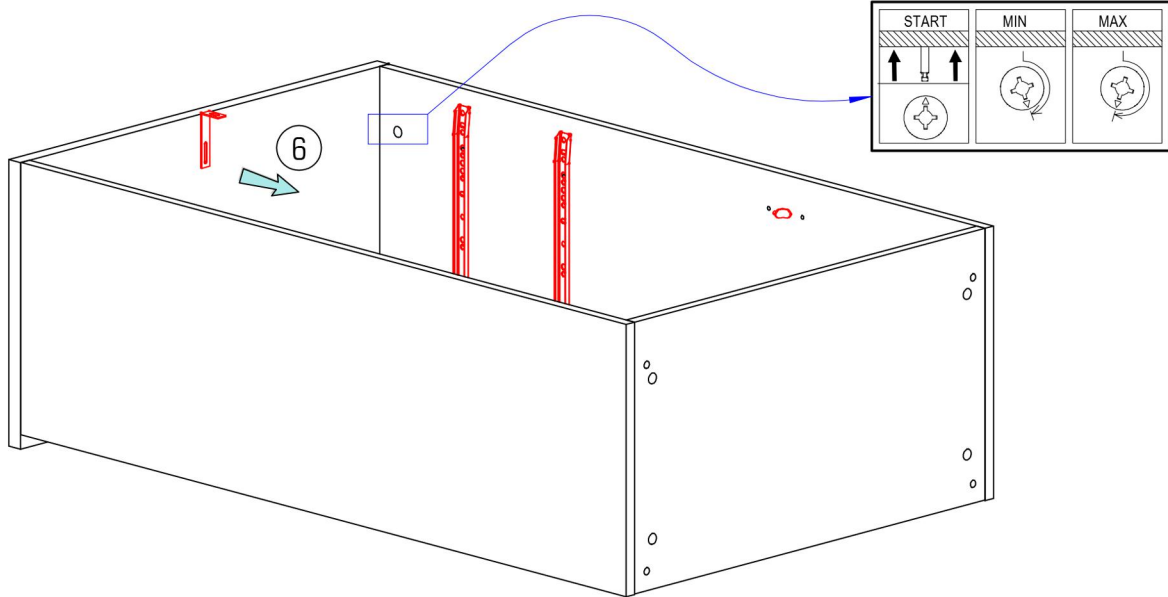

# 4/8 KLAUDIUS TYP 3

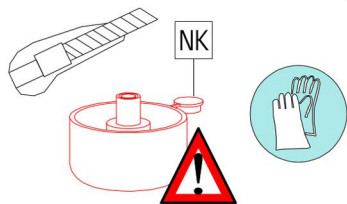
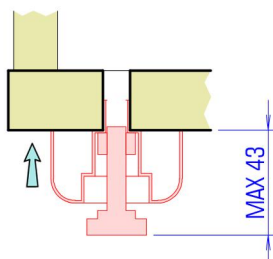
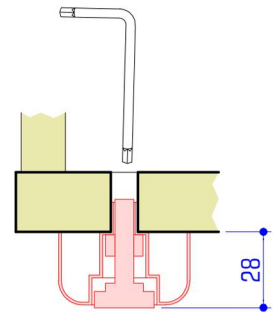
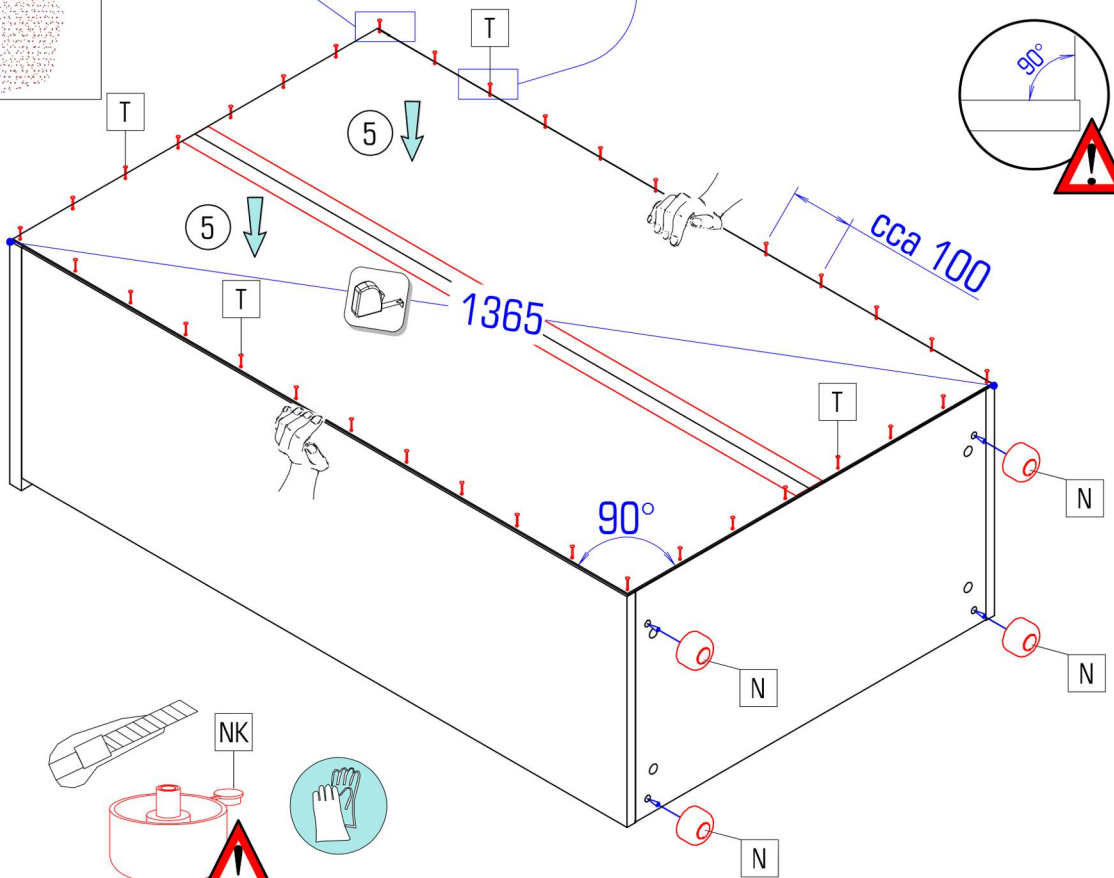
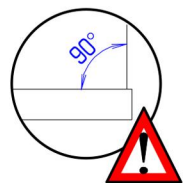
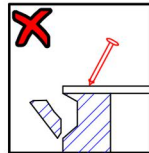
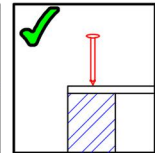
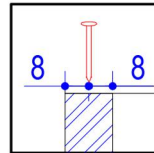
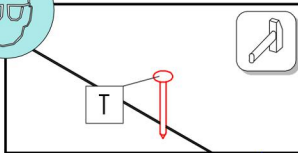
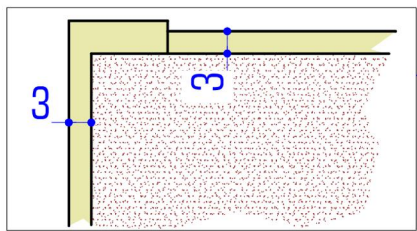
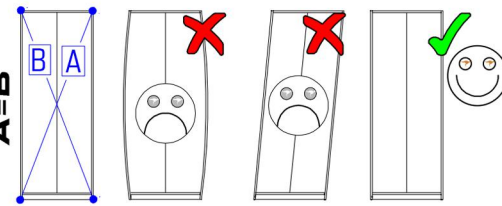
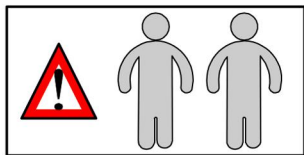

	$\varnothing 50$ v=27		$\varnothing 1,2 \times 20$
N	4x	T	50x



	
Ø5,0x50	Ø10
B 1x	K 1x

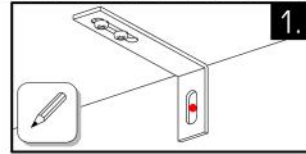

Prudent! Zidul trebuie examinat înainte de asamblare prizele de perete sunt adecvatenumai pentru utilizarea în zidărie fermă, cum ar fi betonul bloc sau cărămidă. Nu folosiți zidăria zidurilor de perete, cum ar fi cărămida goală, blocul ușor, suprafețe cum ar fi gips-carton sau altă încadrare sisteme. Dacă este cazul, trebuie folosite anumite prize de perete! Acestea sunt disponibile la un magazin specializat (magazin de hardware) în caz de nerespectare, producătorul / vânzătorul cu amănuntul sau importatorul nu își asumă răspunderea.

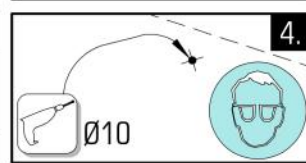
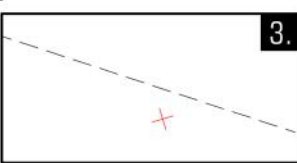
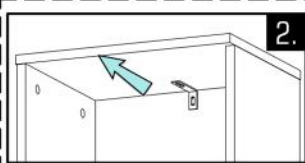

Caution! The wall must be examined before assembly The included universal wall plugs are only suitable for using in firm masonry such as concrete block or brick. Do not use the wall plugs masonry such as hollow brick, lightweight block, surfaces such as gypsum plasterboard or other framing systems. If applicable, particular wall plugs must be used! These are available at a specialised store (hardware store). In case of non-compliance, the manufacturer/retailer or importer do not assume liability.

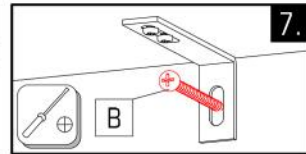
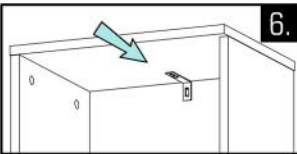
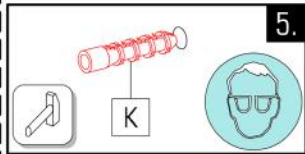

Upozornenie! Pevnosť steny sa musí pred montážou bezpodmienečne skontrolovať. Priložené univerzálne hmoždenky používajte jedine pre pevné murivo ako je betón/tehla. Hmoždenky sa nesmú používať v prípade ľahkého stavebného muriva, dutá tehla, Sádrokartónová doska, alebo iných konštrukcií rámu. U týchto stien je nutné použiť špeciálne hmoždenky! Tieto je možné dostať v špeciálnych predajniach so stavebným materiálom. Pri nedodržíaní pokynov nepreberajú výrobcovia/predajci a dodávateľa zodpovednosť za vzniknuté škody.

Upozornění! Před montáží je nutné zkontrolovat stav stěny. Priložené univerzální hmoždinky jsou určeny pouze k použití pro pevné zdivo jako beton/cihly. Hmoždinky do zdi se nesmí používat u dutinová cihla, zdiva jako pórovitý stavební kámen, sádkartónová deska nebo jiný měkký materiál. U těchto zdív jsou nutné použít speciální hmoždinky! Jsou k dostání v speciálních prodejnách se stavebním materiálem. Při nedodržení těchto pokynů výrobce/prodejce a dovozce neručí za způsobené škody.

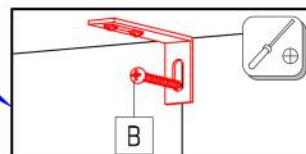
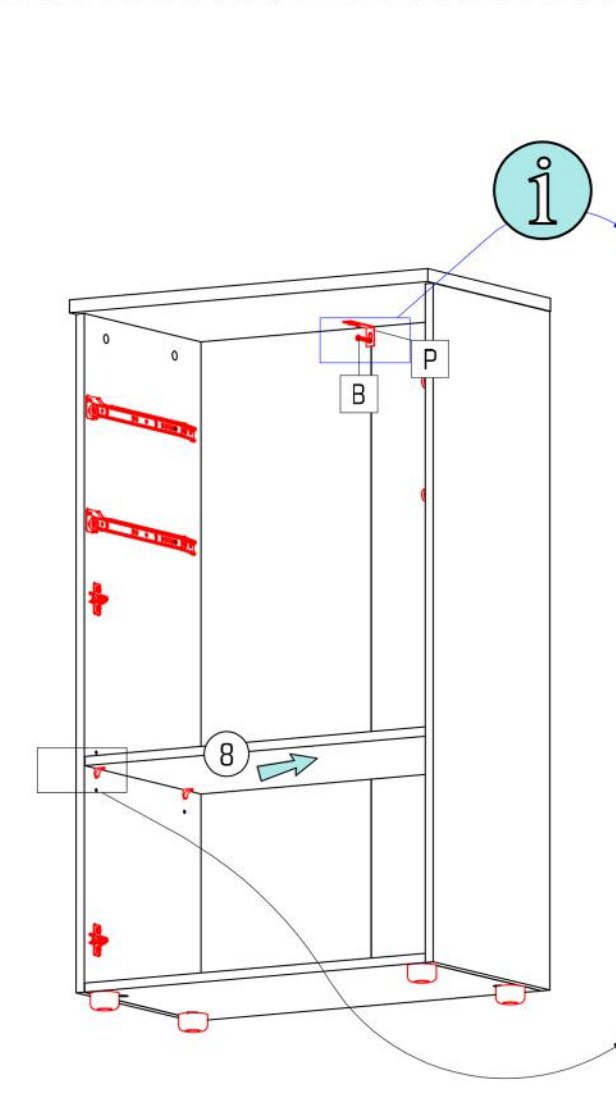

Pažnja! Prije montaže obavezno provjerite svojstvo zida. Priložene univerzalne tiplje namijenjene su isključivo za masivne zidove od betona/opeke. Tiplje za masivne zidove ne smiju se koristiti za zidove kao npr šupljina opeka laki sastavni elementi, gips-kartonske ploče ili drugi modularni načini gradnje. Za te zidove potrebne su eventualno specijalne tiplje! Iste su dostupne u specijaliziranim trgovinama građevinskim materijalom. U slučaju nepridržavanja prethodno navedenih napomena, proizvođač/trgovac i uvoznik ne preuzimaju odgovornost!

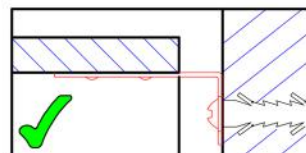

Achtung! Die Wandbeschaffenheit ist vor der Montage unbedingt zu prüfen. Die beigelegten Universaldübel sind ausschließlich nur zur Verwendung für festes Mauerwerk wie Beton/Ziegel. Die Mauerdübel dürfen nicht bei Mauerwerk wie Hohlraumziegel, Leichtbausteinen, Gipskartonplatte oder anderer Rahmenbauweise verwendet werden. Bei diesen Mauerwerken sind gegebenenfalls Spezialdübel zu verwenden! Diese sind in einem Fachgeschäft erhältlich. Bei Nichteinhaltung wird seitens Produzenten/Händler und Importeur keine Haftung übernommen.

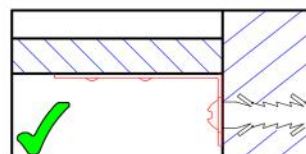

Vigyázat! Szerelés előtt a falfelületet feltétlenül vizsgálja meg. A mellékelt univerzális tiplje kizárólag stabil falazathoz használható mint például beton/tégla. A fali tiplje nem használható könnyű építőkövekhez, üreg tégla, gipszkarton lapokhoz vagy más fűvázas építményekhez. Ezekhez a falfelületekhez csak speciális tiplje használhatóak, melyek szaküzletekben (barkácsruházakban) beszerezhetőek. Fentiek figyelmen kívül hagyása esetén a gyártó/kereskedő vagy forgalmazó nem vállal felelősséget.

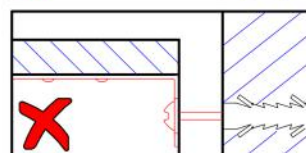

OBS! Väggens sammansättning ska absolut kontrolleras innan montering. De bifogade pluggarna får endast användas för stabila och fasta väggar, som t.ex. betong/tegel. De får absolut inte användas för kavitet tegel, väggar ur fonolit, gipsskivor eller dylikt. För dessa väggar måste det användas speciella pluggar, som finns att köpa i specialiserad handel (byggmarknad). Varken tillverkare, handlare eller importör övertar ansvar, om dessa anvisningar inte följs.

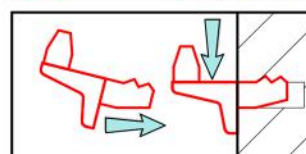

Pozor! Pred montažo preverite stanje stene. Priloženi univerzalni mozniki so izključno samo za uporabo na čvrstem zidovju, kot sta beton in opeka. Stenski mozniki se ne smejo uporabljati pri zidovju kot so votlina opeke, zidaki za lahko gradnjo, mavčne plošče ali druge okvirne gradnje. Pri teh zidovjih morate v danih primerih uporabljati posebne moznike. Ti so na voljo v specializiranih trgovinah (trgovinah z gradbenim materialom) Pri upoštevanju se s strani proizvajalca/trgovca in uvoznika ne prevzame jamstvo.

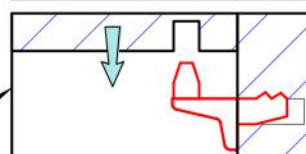

Uwaga! Ścianę należy sprawdzić przed montażem. Dołączone uniwersalne kołki rozporowe są odpowiednie tylko do stosowania w mocnych murach, takich jak beton lub cegła. Nie robć za pomocą kołków rozporowych murowanych, takich jak pustak, lekka kostka, powierzcnie takie jak płyty gipsowo-kartonowe lub inne systemy ram. Jeśli dotyczy, muszą to być określone kołki rozporowe być użytym! Są one dostępne w specjalistycznym sklepie niezgodność, producent / sprzedawca lub importer nie ponoszą odpowiedzialności.

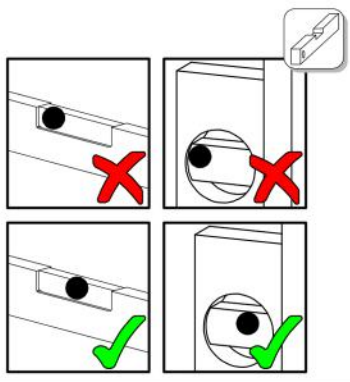



### RO AVERTISMENT

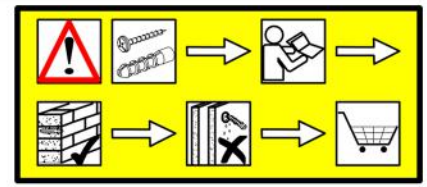
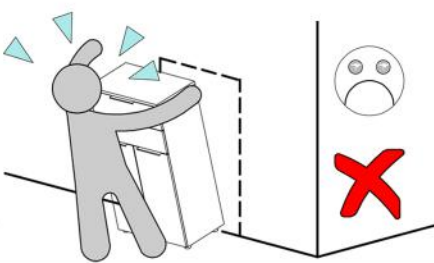



- EN WARNING
- SK VÝSTRAHA
- CZ VAROVÁNÍ
- HR UPOZORENJE
- DE WARNUNG
- HU FIGYELEM
- SE VARNING
- SI OPOZORILO
- PL OSTRZEŻENIE



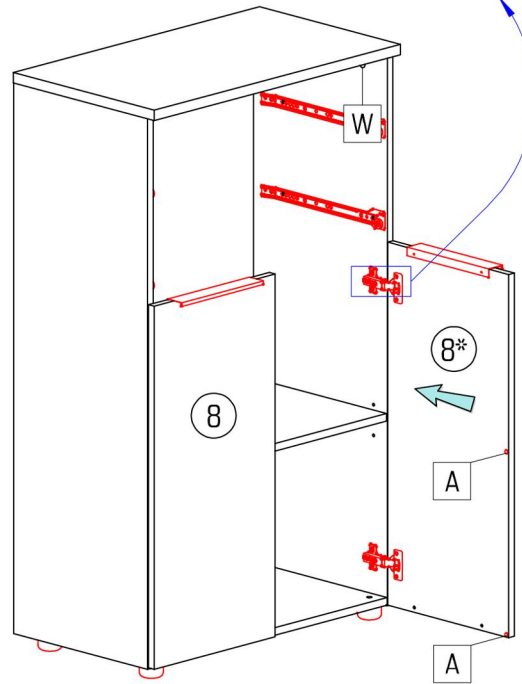
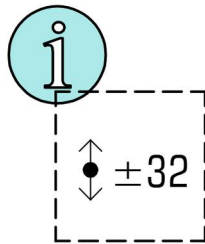
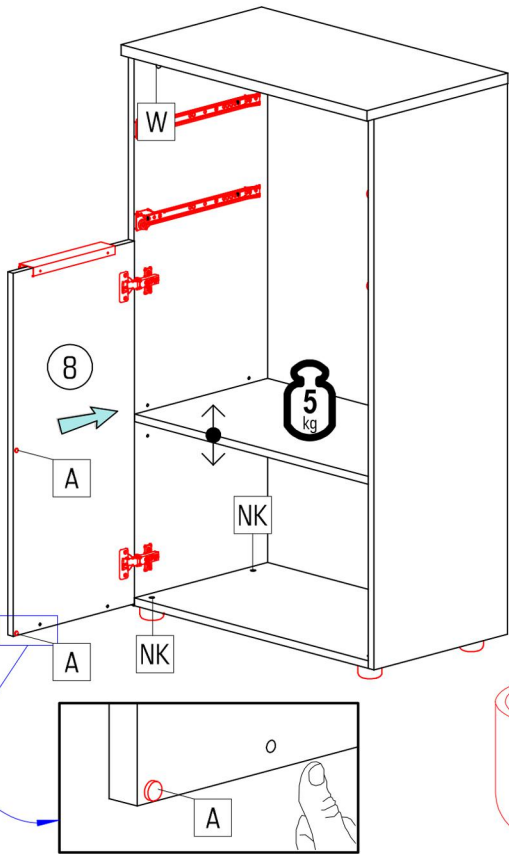
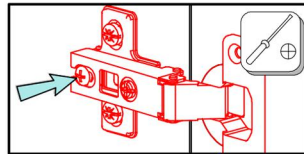



# 6/8 KLAUDIUS TYP 3

	Ø8		
A	2x	W	4x

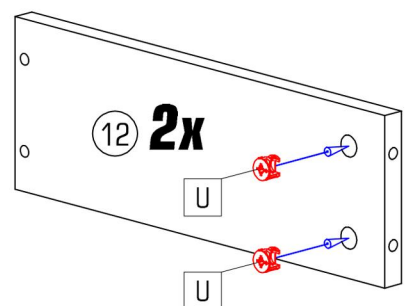
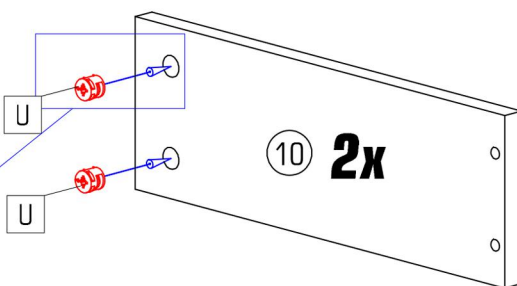
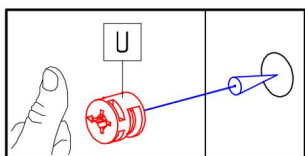
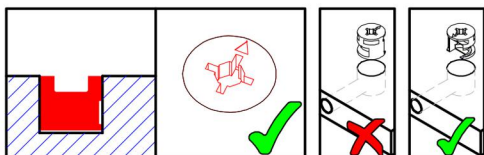
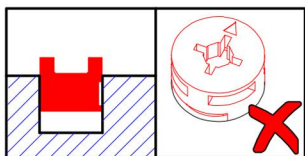
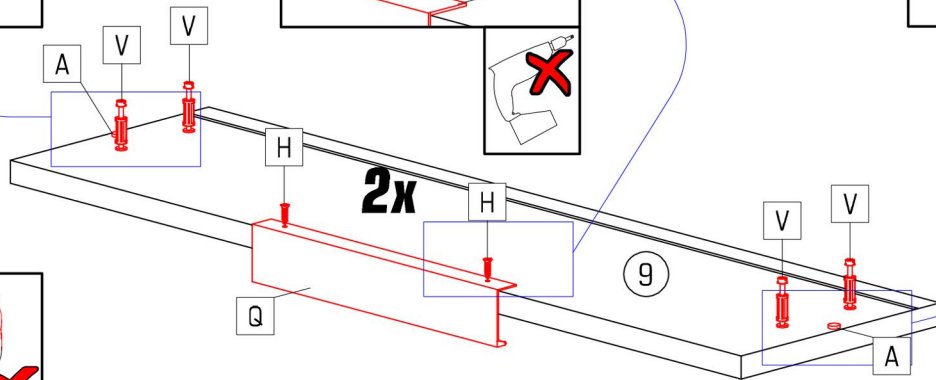
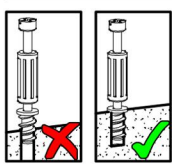
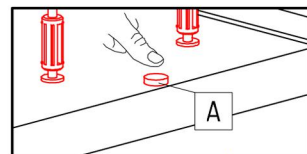
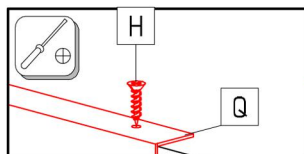
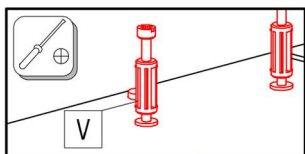

	Ø8		Ø3,0x12		L=230		Ø15x13		
A	2x	H	4x	Q	2x	U	8x	V	8x

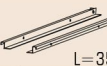
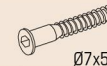

				
D	E	F	S	W
12x	12x	2x	8x	8x

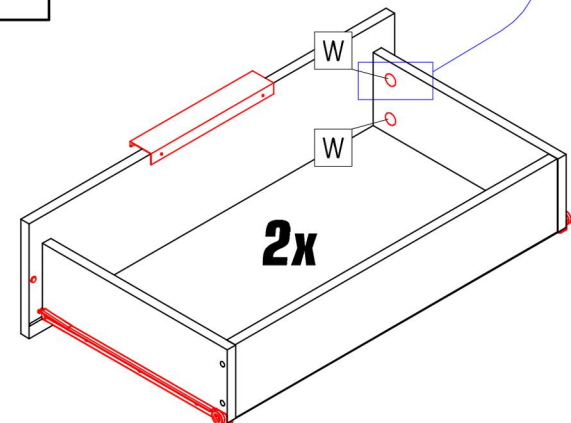
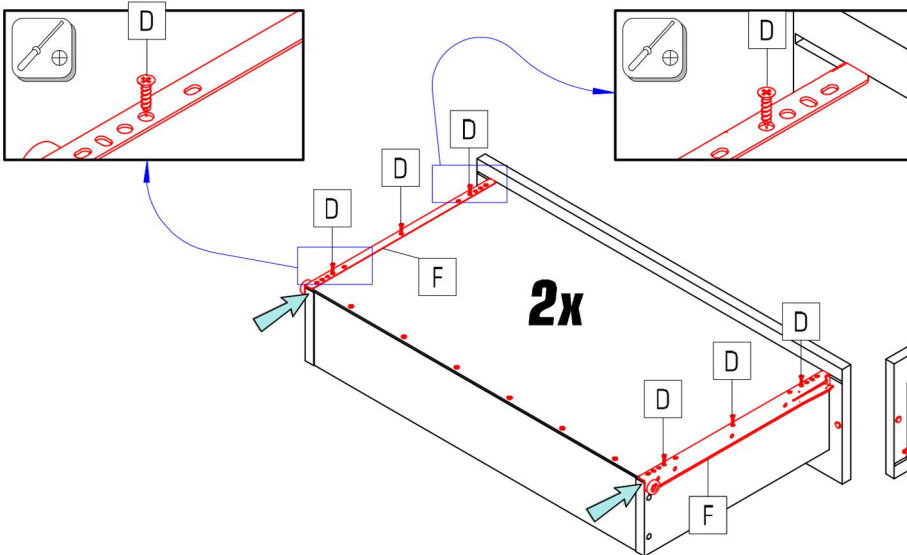
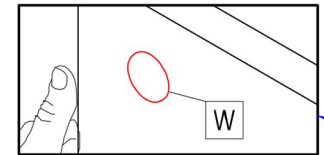
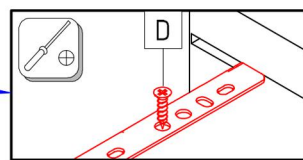
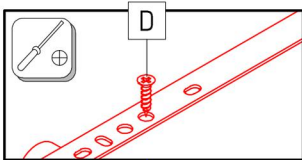
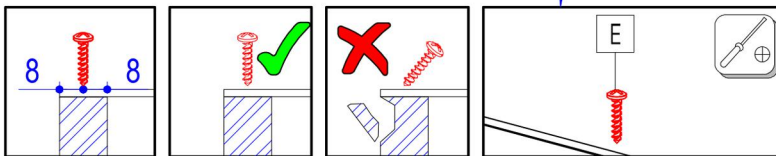
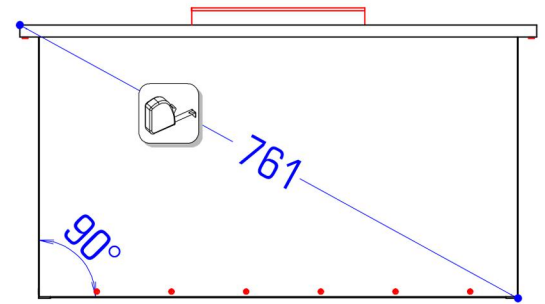
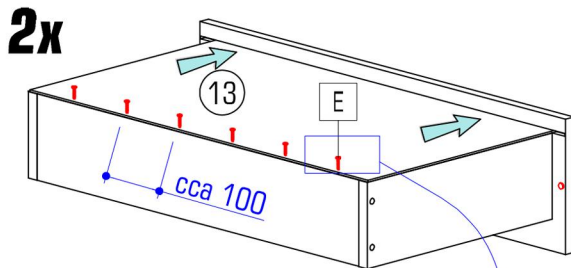
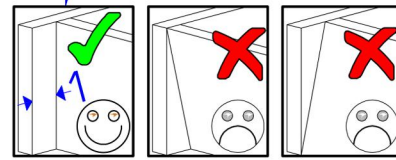
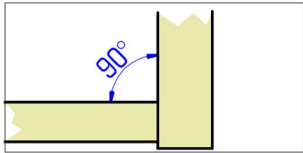
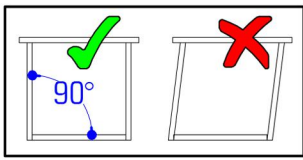
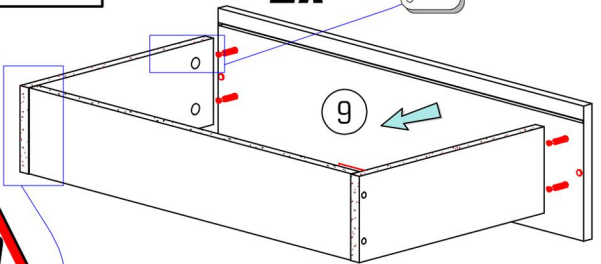
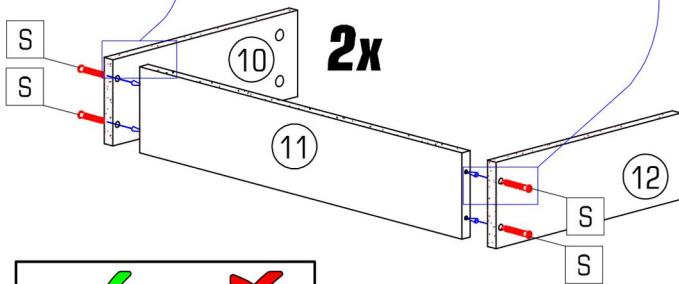
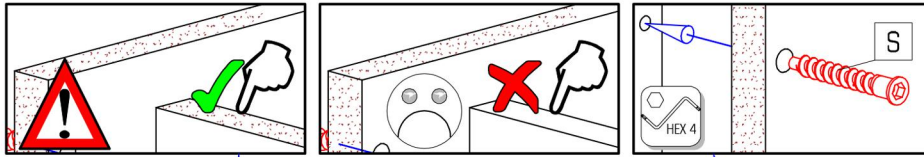
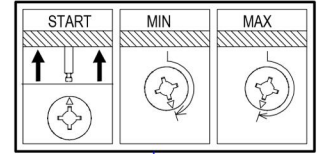

# 8/8 KLAUDIUS TYP 3

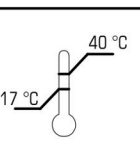
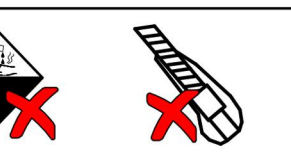
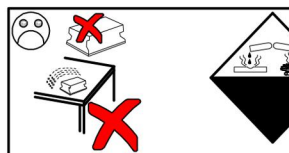
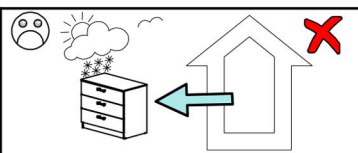
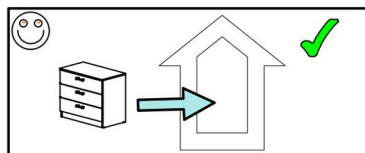
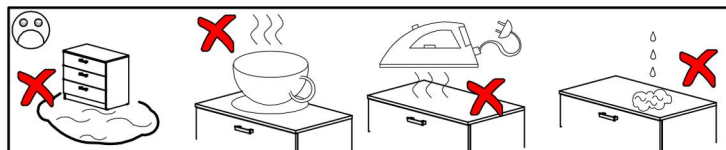
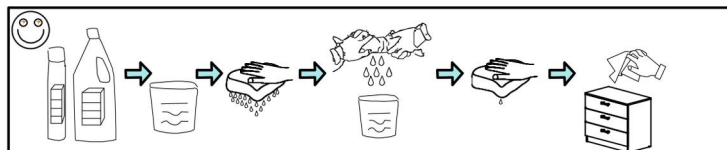
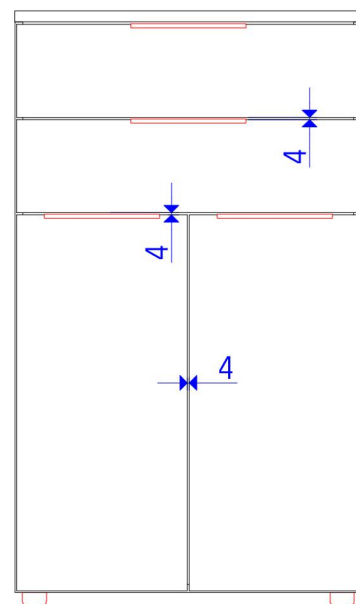
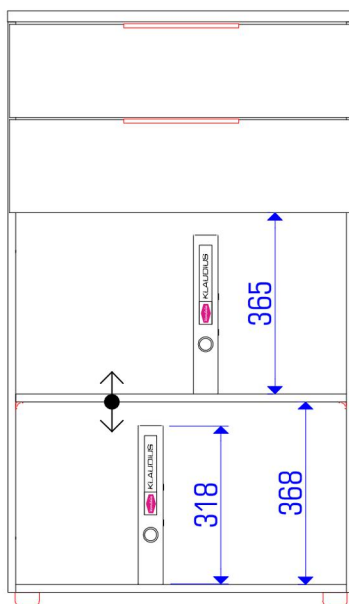
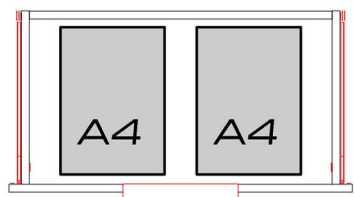
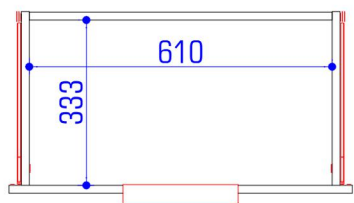
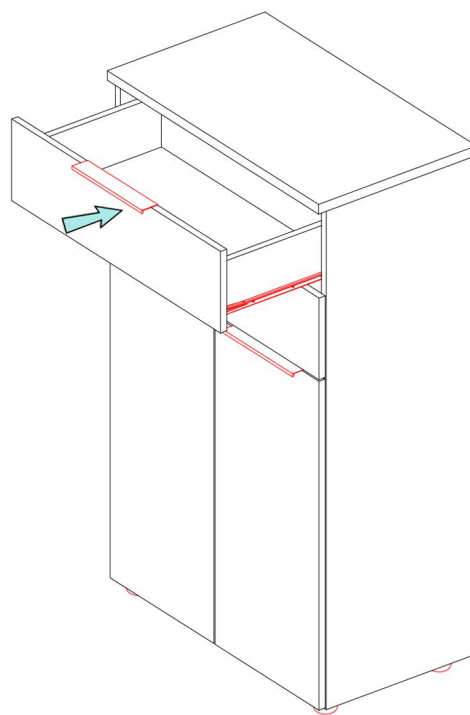
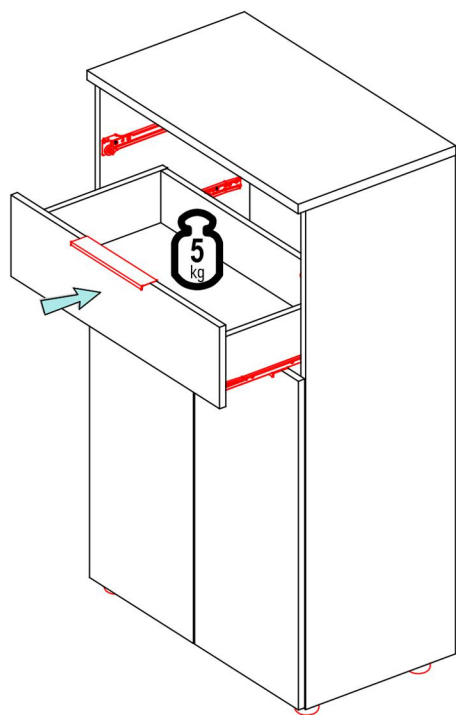

# KLAUDIUS TYP4

Art.-Nr.

394 625  
394 616

700  
1200  
400  
mm

1/6

v0

16-2024

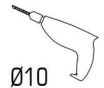
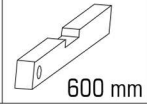
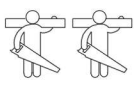

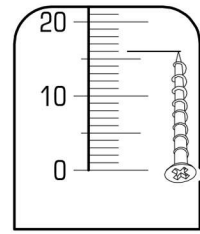
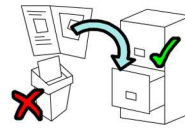
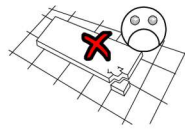
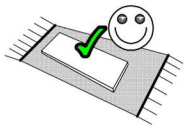
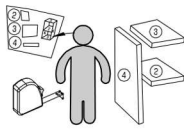
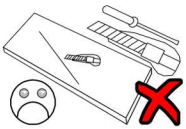
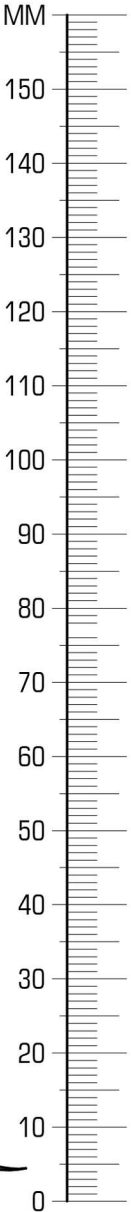
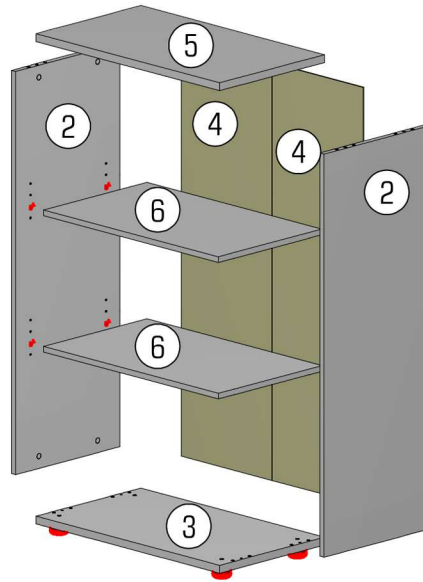
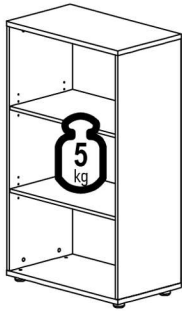

ID	ID			
21094	②	1128*398*16	2x	1/1
21085	③	700*400*22	1x	1/1
21095	④	347*1168*3	2x	1/1
21087	⑤	700*400*22	1x	1/1
21088	⑥	666*394*16	2x	1/1

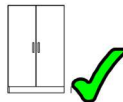
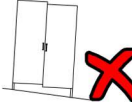

22800.01		4	22256.00		Ø5,0x70	22244.01		Ø3,5x16	
A	1x	B	1x	E	2x	F	8x		
24101.00		Ø10	27000.00		Ø8x30	8501.00		30082.01	
K	1x	L	16x	M	8x	N	4x		
31108.00		21102.00		Ø1,6x20	70013.01		Ø15x13	70021.01	
P	1x	T	50x	U	8x	V	8x		



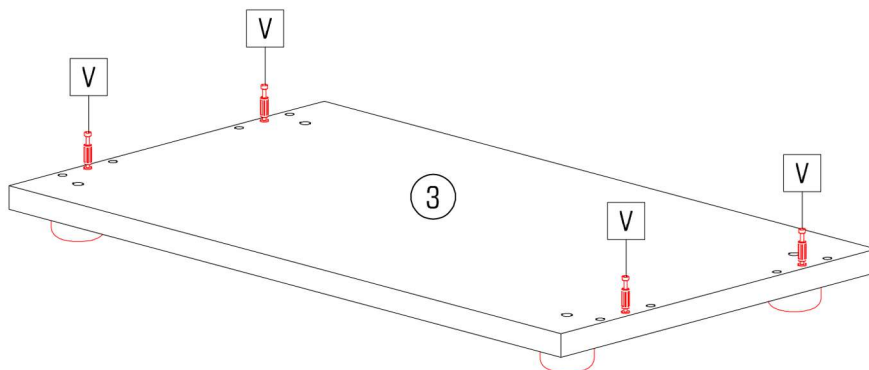
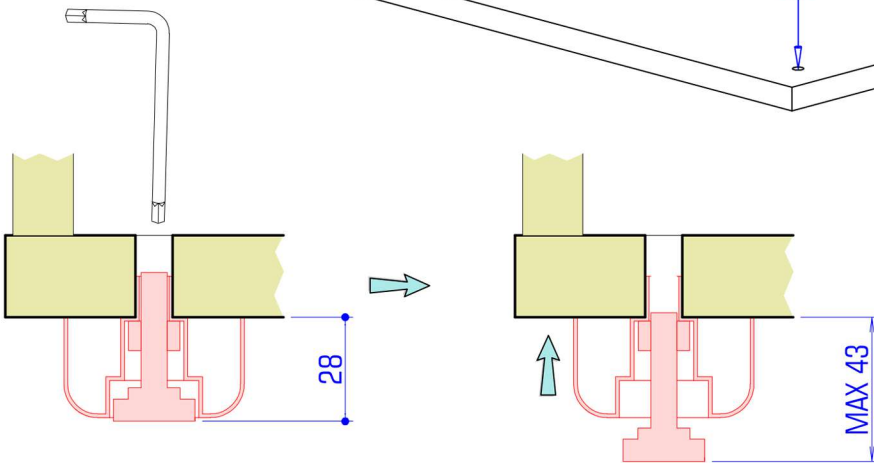
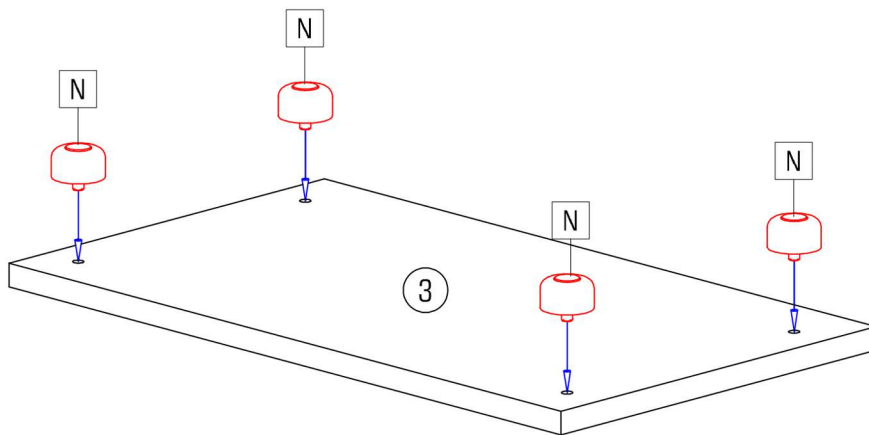
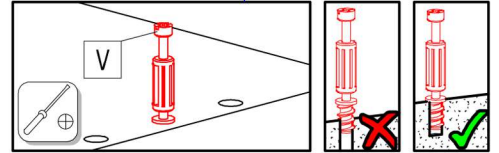
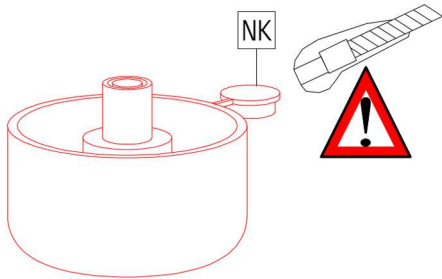
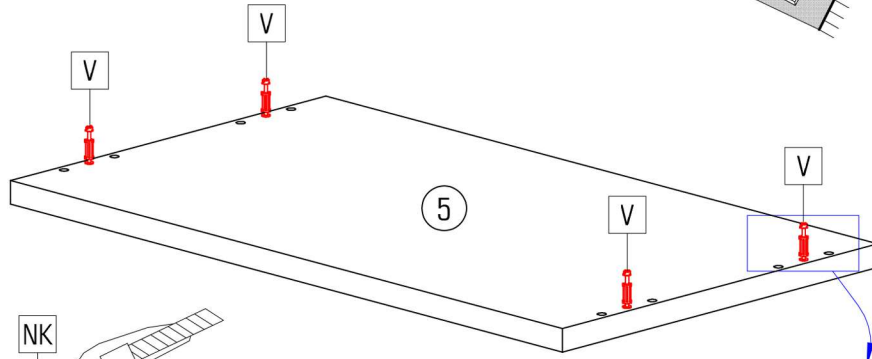
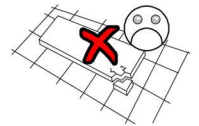
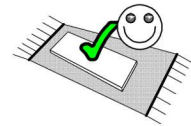

# 2/6 KLAUDIUS TYP4

	
Ø50 v=28	
N 4x	V 8x



# KLAUDIUS TYP4 3/6

		
L 16x	M 8x	U 8x

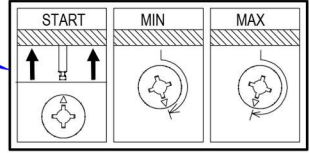
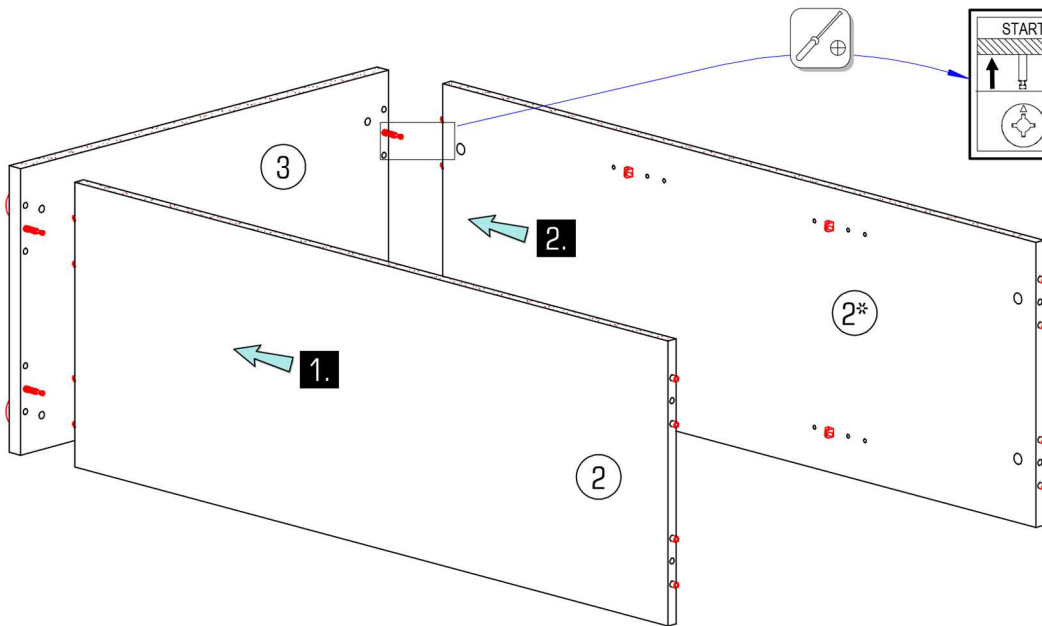
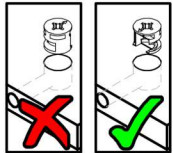
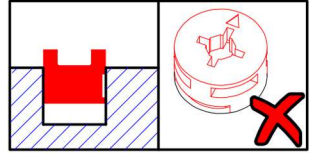
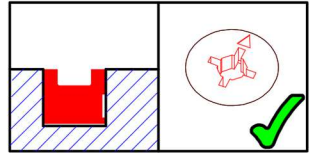
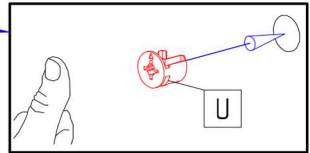
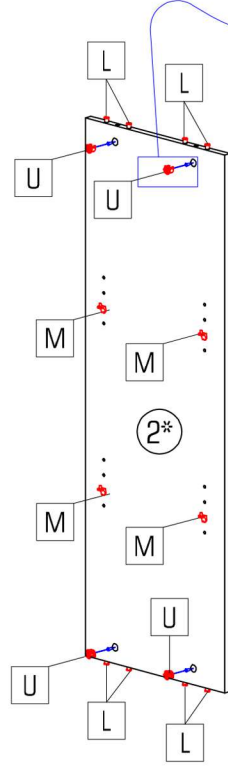
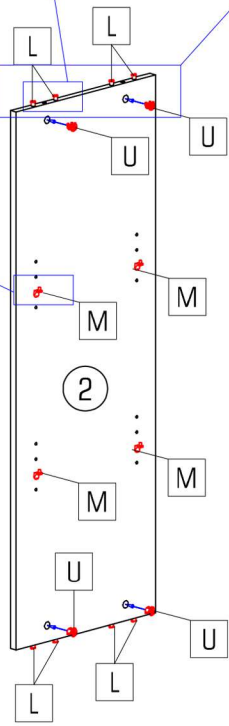
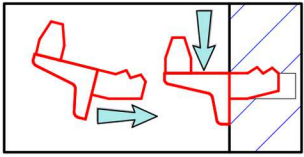
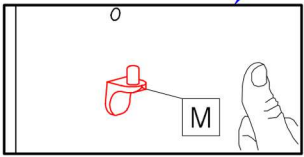
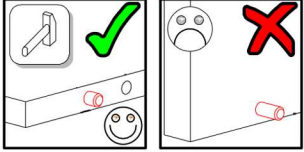
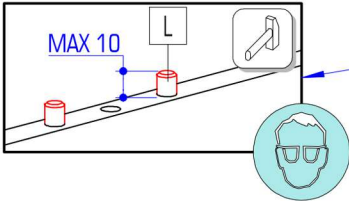
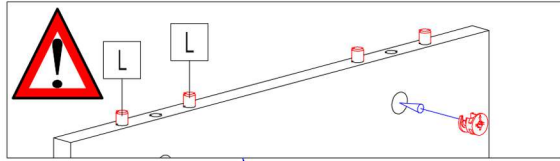





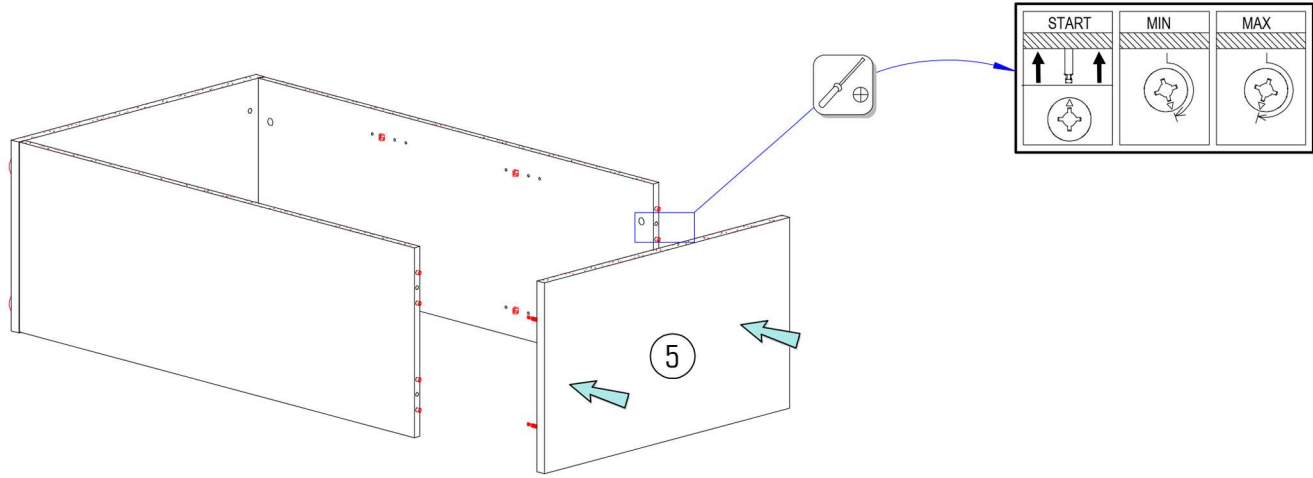

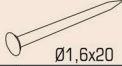
# 4/6 KLAUDIUS TYP4

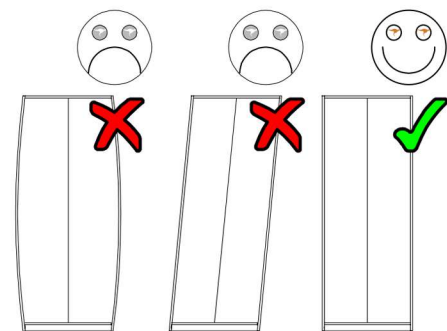
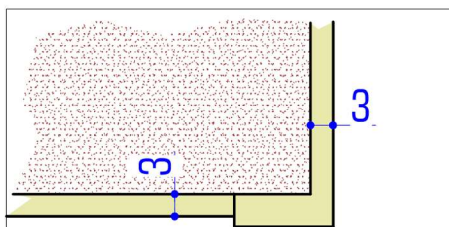
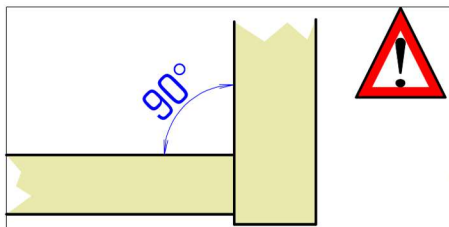
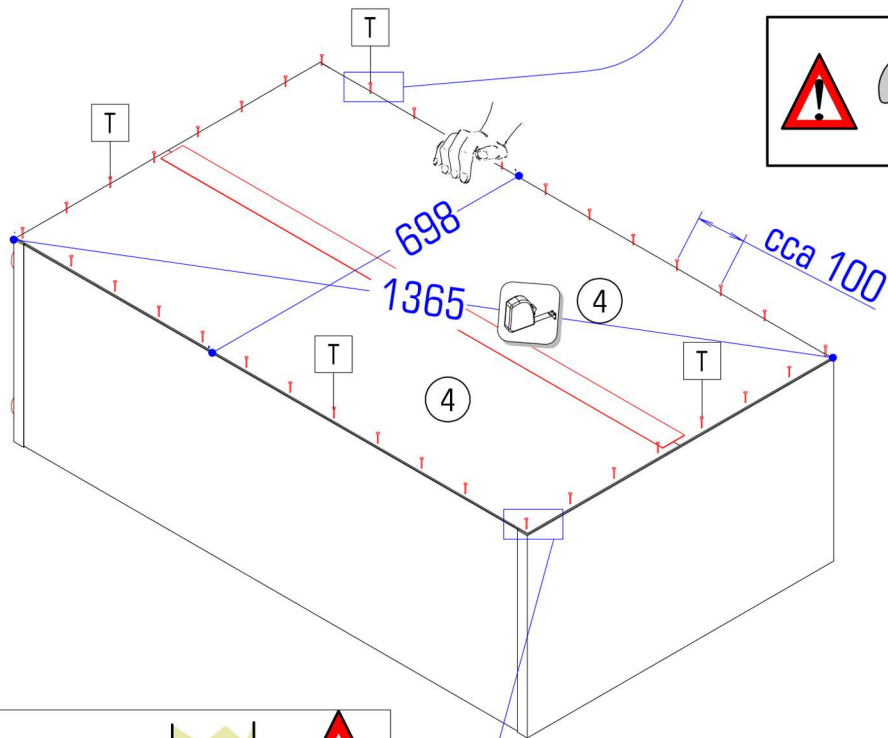
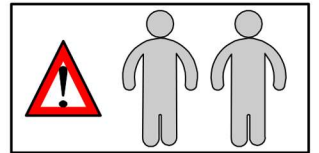
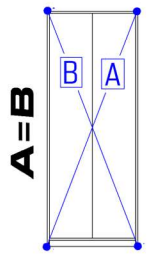
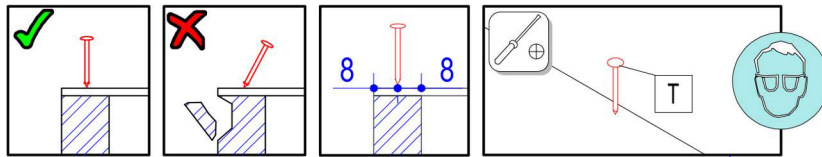

	Ø1,6x20
T	50x



			
B 1x	E 2x	K 1x	P 1x

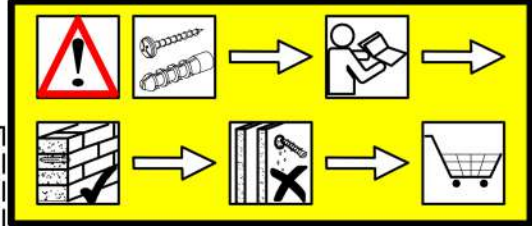

**Caution!** The wall must be examined before assembly. The included universal wall plugs are only suitable for using in firm masonry such as concrete block or brick. Do not use the wall plugs masonry such as hollow brick, lightweight block, surfaces such as gypsum plasterboard or other framing systems. If applicable, particular wall plugs must be used! These are available at a specialised store (hardware store). In case of non-compliance, the manufacturer/retailer or importer do not assume liability.

**Upozornenie!** Pevnosť steny sa musí pred montážou bezpodmienečne skontrolovať. Priložené univerzálne hmoždenky používajte jedine pre pevné murivo ako je betón/tehla. Hmoždenky sa nesmú používať v prípade ľahkého stavebného muriva, dutá tehla, sádkokartónová doska, alebo iných konštrukcií rámu. U týchto stien je nutné použiť špeciálne hmoždenky! Tieto je možné dostať v špeciálnych predajniach so stavebným materiálom. Pri nedodržení pokynov nepreberajú výrobcovia/predajci a dodávateľa zodpovednosť za vzniknuté škody.

**Upozornění!** Před montáží je nutné zkontrolovat stav stěny. Přiložené univerzální hmoždinky jsou určeny pouze k použití pro pevné zdivo jako beton/cihly. Hmoždinky do zdi se nesmí používat u dutinová cihla, zdiva jako pórovitý stavební kámen, sádkokartónová deska nebo jiný měkký materiál. U těchto zdív jsou nutné použít speciální hmoždinky! Jsou k dostání v speciálních prodejnách se stavebním materiálem. Při nedržení těchto pokynů výrobce/prodejce a dovozce neručí za způsobené škody.

**Pažnja!** Prije montaže obvezno provjerite svojstvo zida. Priložene univerzalne tiplje namijenjene su isključivo za masivne zidove od betona/opeke. Tiplje za masivne zidove ne smiju se koristiti za zidove kao npr šupljina opeka laki sastavni elementi, gips-kartonske ploče ili drugi modularni načini gradnje. Za te zidove potrebne su eventualno specijalne tiplje! Iste su dostupne u specijaliziranim trgovinama građevinskim materijalom. U slučaju nepridržavanja prethodno navedenih napomena, proizvođač/trgovac i uvoznik ne preuzimaju odgovornost!

**Achtung!** Die Wandbeschaffenheit ist vor der Montage unbedingt zu prüfen. Die beigelegten Universaldübel sind ausschließlich nur zur Verwendung für festes Mauerwerk wie Beton/Liegel. Die Mauerdübel dürfen nicht bei Mauerwerk wie Hohlraumziegel, Leichtbausteinen, Gipskartonplatte oder anderer Rahmenbauweise verwendet werden. Bei diesen Mauerwerken sind gegebenenfalls Spezialdübel zu verwenden! Diese sind in einem Fachgeschäft erhältlich. Bei Nichteinhaltung wird seitens Produzenten/Händler und Importeur keine Haftung übernommen.

**Vigyázat!** Szerelés előtt a falfelületet feltétlenül vizsgálja meg. A mellékelt univerzális tiplje kizárólag stabil falazathoz használható mint például beton/tégla. A fal tiplje nem használható könnyű építőkövekhez, üreg tégla, gipszkarton lapokhoz vagy más favázás építményekhez. Ezekhez a falfelületekhez csak speciális tiplik használhatóak, melyek szaküzletekben (barkácsruházakban) beszerezhetőek. Figyeljen kívül hagyása esetén a gyártó/kereskedő vagy forgalmazó nem vállal felelősséget.

**Prudentă!** Zidul trebuie examinat înainte de asamblare prizele de perete sunt adecvate numai pentru utilizarea în zidărie fermă, cum ar fi betonul bloc sau cărămidă. Nu folosiți zidăria zidurilor de perete, cum ar fi cărămidă goală, blocul ușor, suprafețe cum ar fi gips-carton sau alți încadrare sisteme. Dacă este cazul, trebuie folosite anumite prize de perete! Acestea sunt disponibile la un magazin specializat (magazin de hardware). În caz de nerespectare, producătorul / vânzătorul cu amănuntul sau importatorul nu își asumă răspunderea.

**Uwaga!** Ścianę należy sprawdzić przed montażem. Dołączone uniwersalne kołki rozporowe są odpowiednie tylko do stosowania w mocnych murach, takich jak beton lub cegła. Nie rób za pomocą kołków rozporowych mury, takich jak pustak, lekka kostka, powierzchnie takie jak płyty gipsowo-kartonowe lub inne systemy ram. Jeśli dotyczy, muszą to być określone kołki rozporowe być użyty! Są one dostępne w specjalistycznym sklepie niezgodność, producent / sprzedawca lub importer nie ponoszą odpowiedzialności.

**Pozor!** Pred montažo proverite stanje stene. Priloženi univerzalni mozniki so izključno samo za uporabo na čvrstem zidovju, kot sta beton in opeka. Stenski mozniki se ne smejo uporabljati pri zidovju kot so votlina opeke, zidaki za lahko gradnjo, mavčne plošče ali druge okvirne gradnje. Pri teh zidovjih morate v danih primerih uporabljati posebne moznike. Ti so na voljo v specializiranih trgovinah (trgovinah z gradbenim materialom) Pri upoštevanju se s strani proizvajalca/trgovca in uvoznika ne prevzame jamstvo.

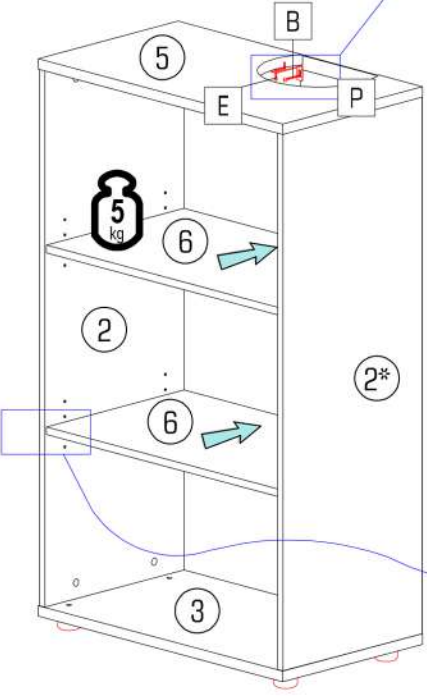
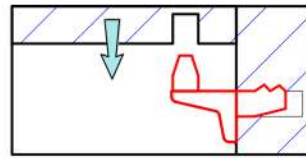
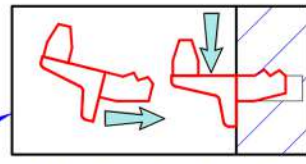
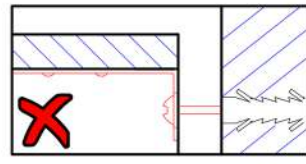
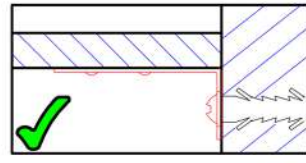
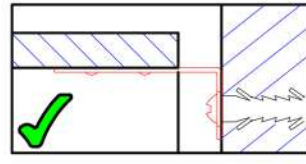
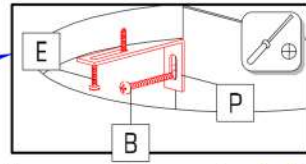
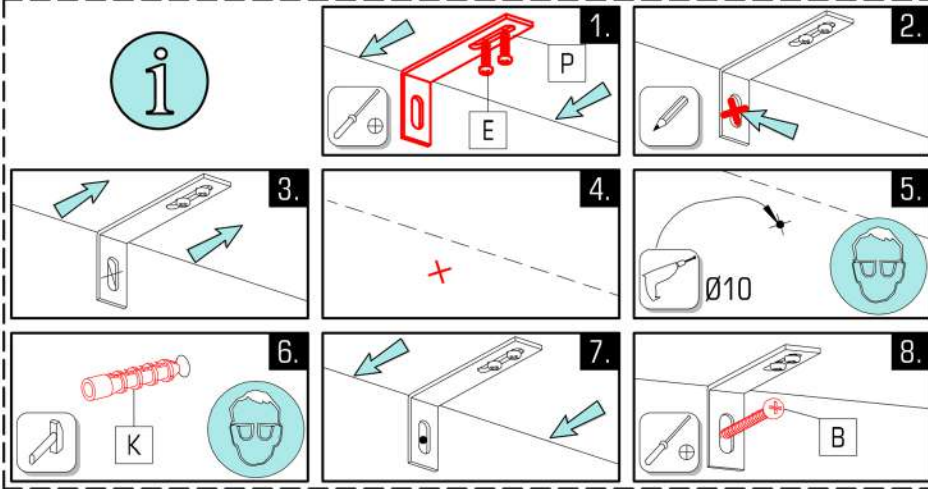

**RO AVERTISMENT**

- EN WARNING
- SK VÝSTRAHA
- CZ VAROVÁNÍ
- HR UPOZORENIE
- DE WARNUNG
- HU FIGYELEM
- SE VARNING
- SI OPOZORILO
- PL OSTRZEŻENIE

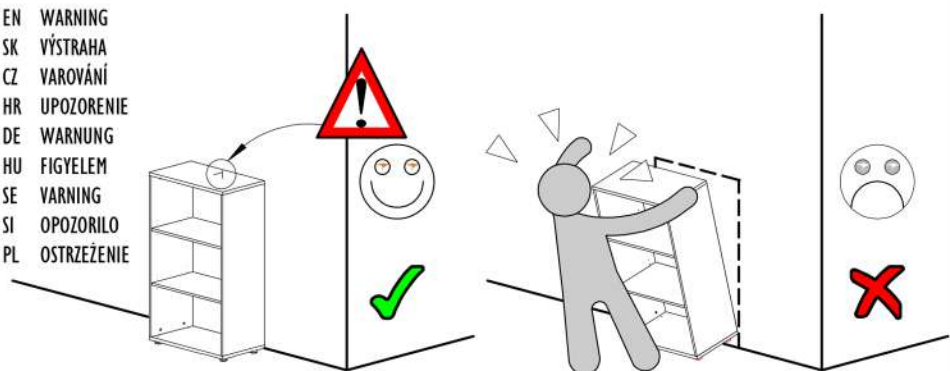
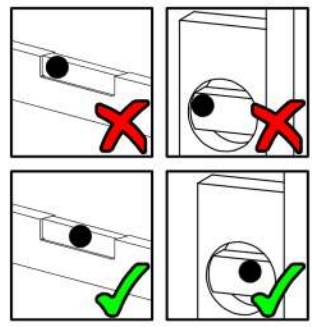

# 6/6 KLAUDIUS TYP4



F 8x

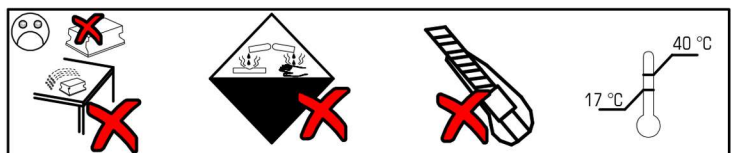
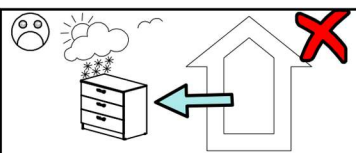
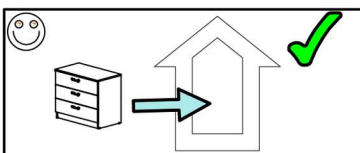
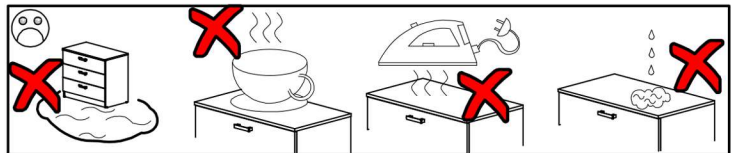
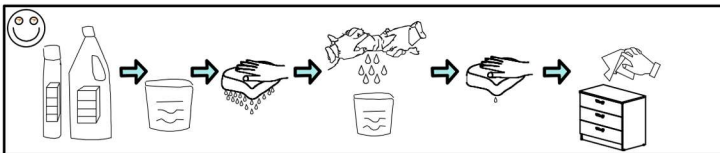
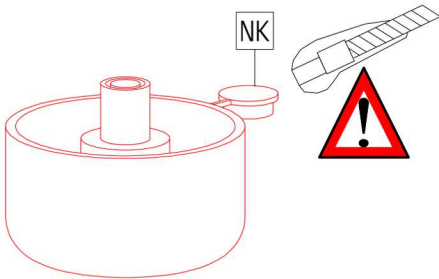
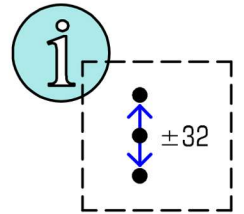
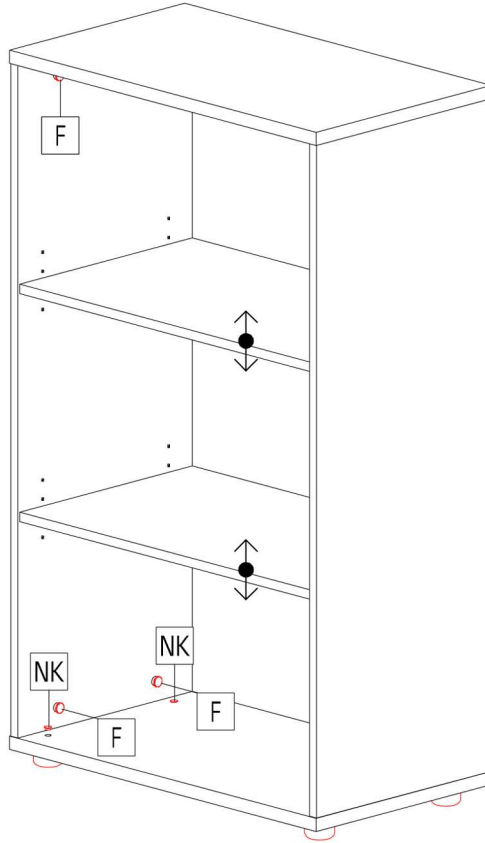

# KLAUDIUS TYP 9

Art.-Nr.

397 088

↔	1300	1/8
↕	760	
↗	1200	
	mm	VO
		28-2024

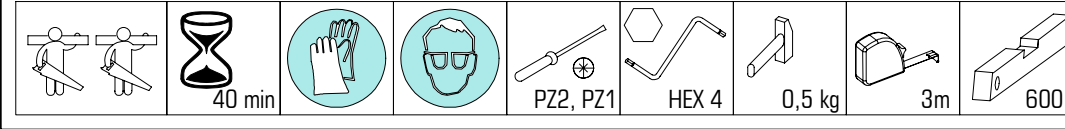

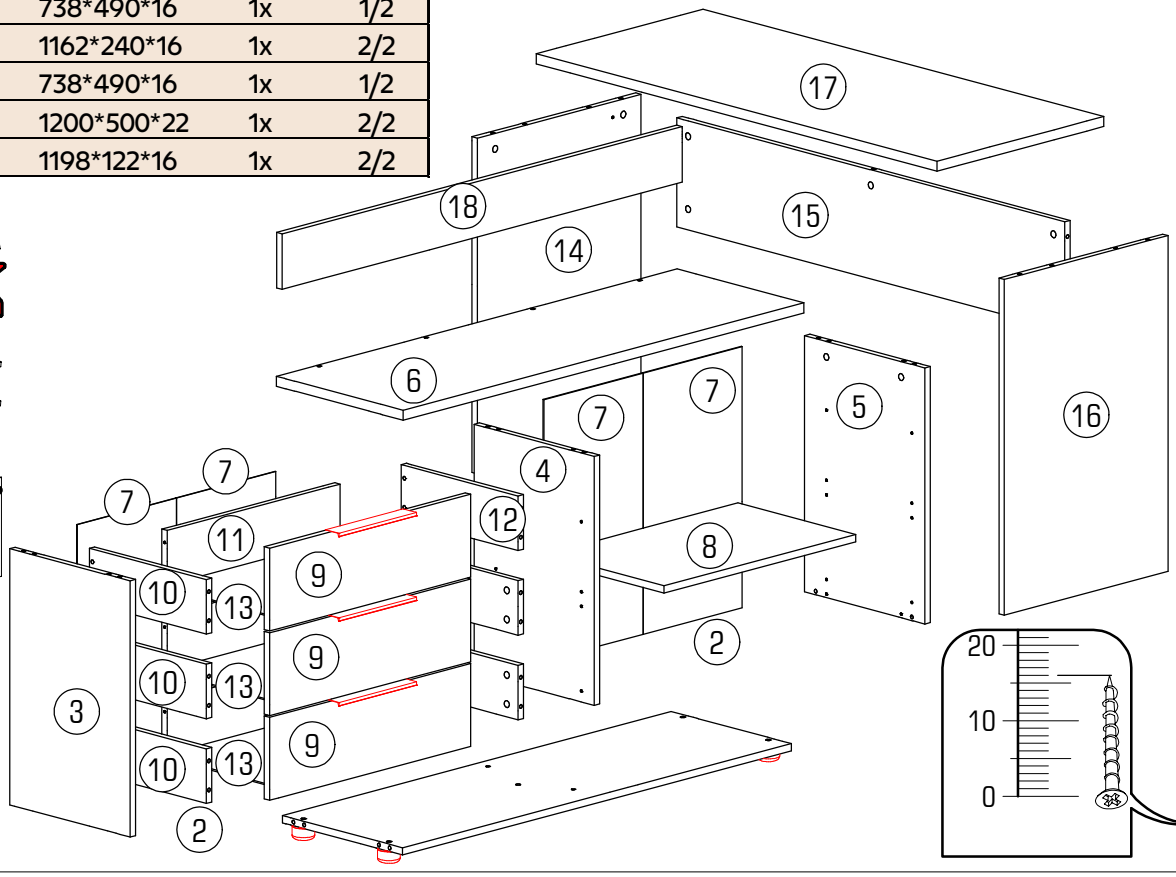
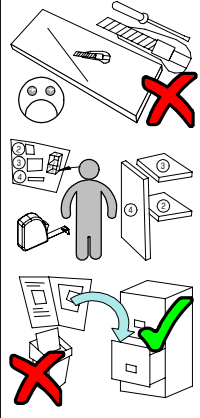
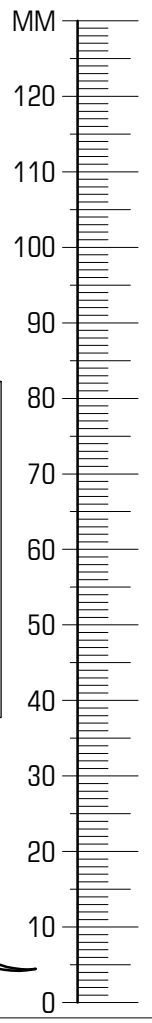
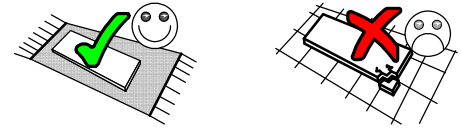
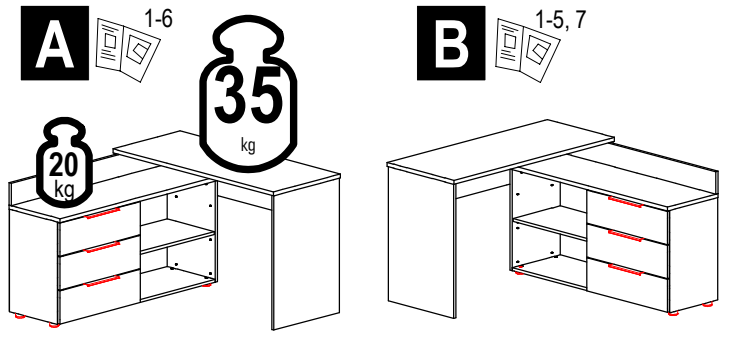

ID	ID			
21524	②	1164*360*16	1x	2/2
21525	③	563*360*16	1x	1/2
21526	④	547*360*16	1x	1/2
21527	⑤	563*360*16	1x	1/2
21528	⑥	1200*380*22	1x	2/2
21529	⑦	297*574*3	4x	1/2
21507	⑧	574*353*16	1x	1/2
21530	⑨	602*182*16	3x	1/2
19025	⑩	350*120*16	3x	2/2
21509	⑪	518*120*16	3x	1/2 2/2
19027	⑫	350*120*16	3x	2/2
21510	⑬	548*356*3	3x	1/2
21531	⑭	738*490*16	1x	1/2
21512	⑮	1162*240*16	1x	2/2
21532	⑯	738*490*16	1x	1/2
21533	⑰	1200*500*22	1x	2/2
21534	⑱	1198*122*16	1x	2/2



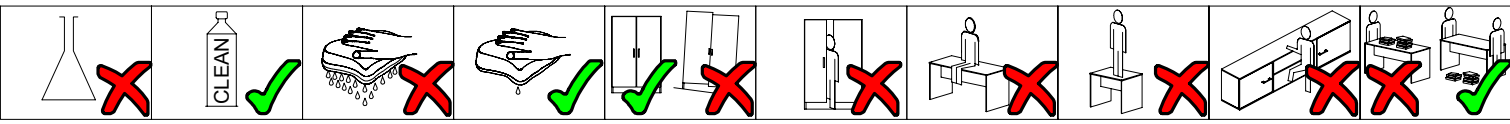

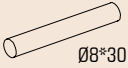

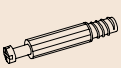

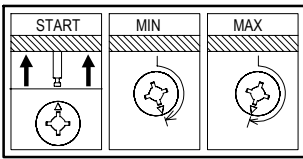
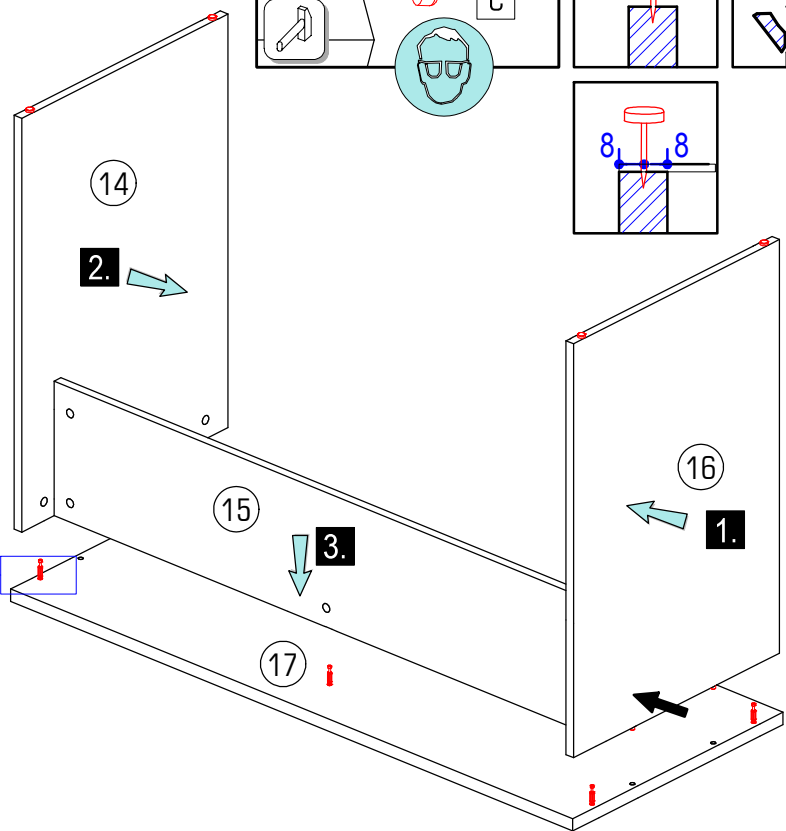
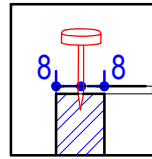
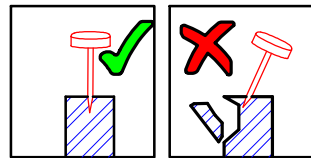
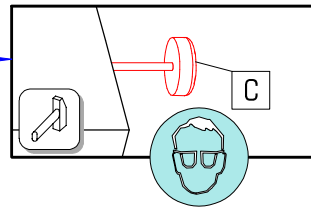
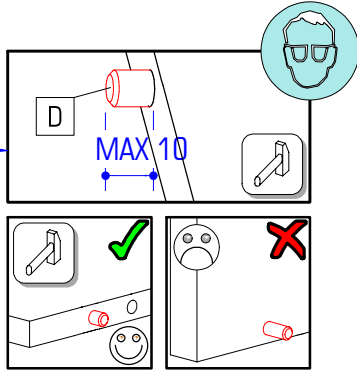
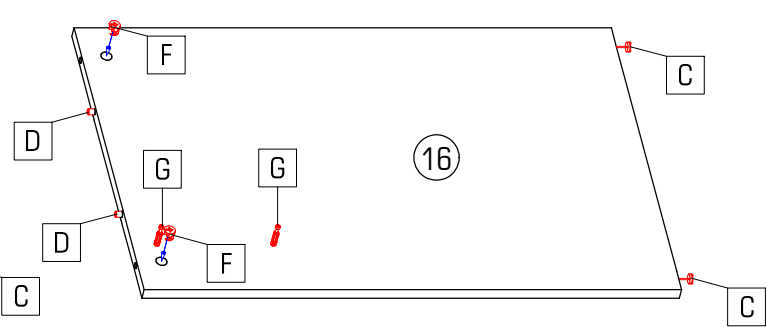
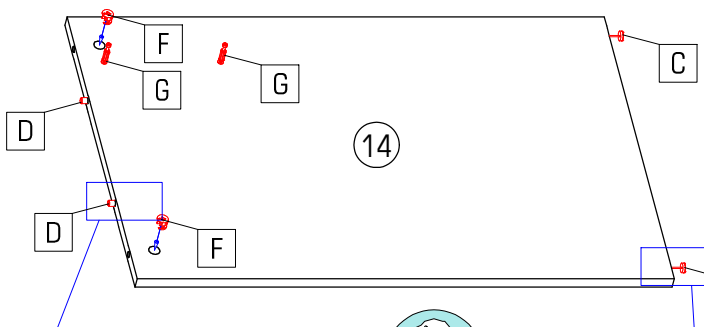
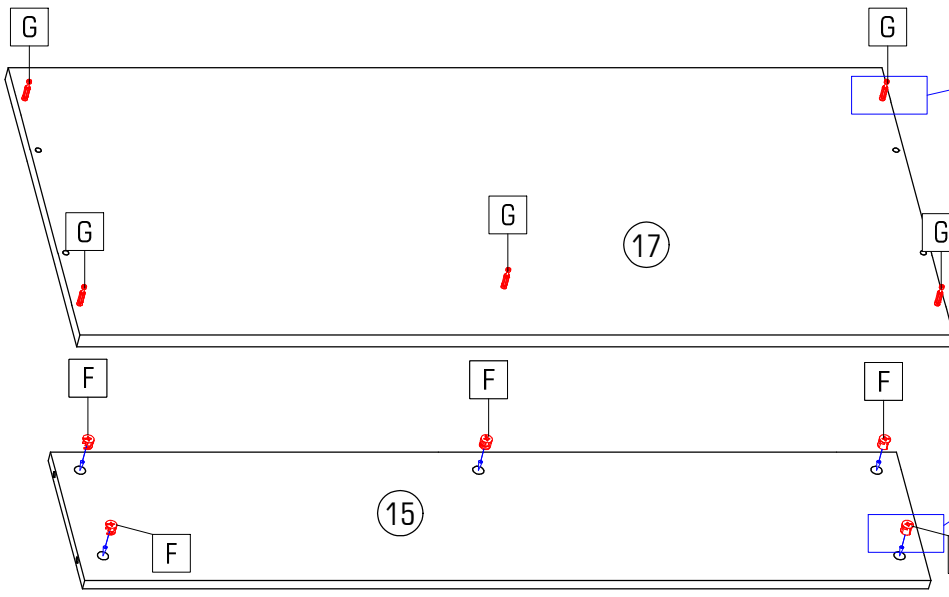
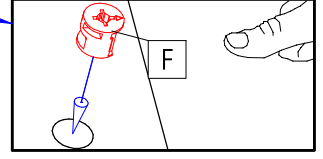
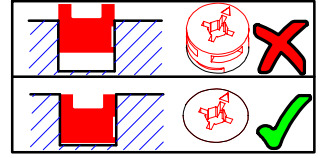
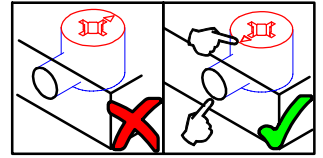
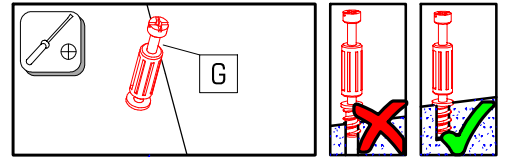

	8501.00		22244.01		30091.00		27000.00		70013.01		70021.01		22300.00		22705.00		22705.00
A	4x	B	15x	C	4x	D	14x	E	11x	F	31x	G	31x	H	18x	J	12x
	22243.00		22236.00		21102.00		33006.01		33006.01		22234.00		24008.00		32246.01		30082.01
K	24x	L	16x	M	6x	N	50x	P	3x	Q	3x	R	6x	S	6x	T	3x

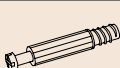



			
C	D	F	G
4x	4x	9x	9x

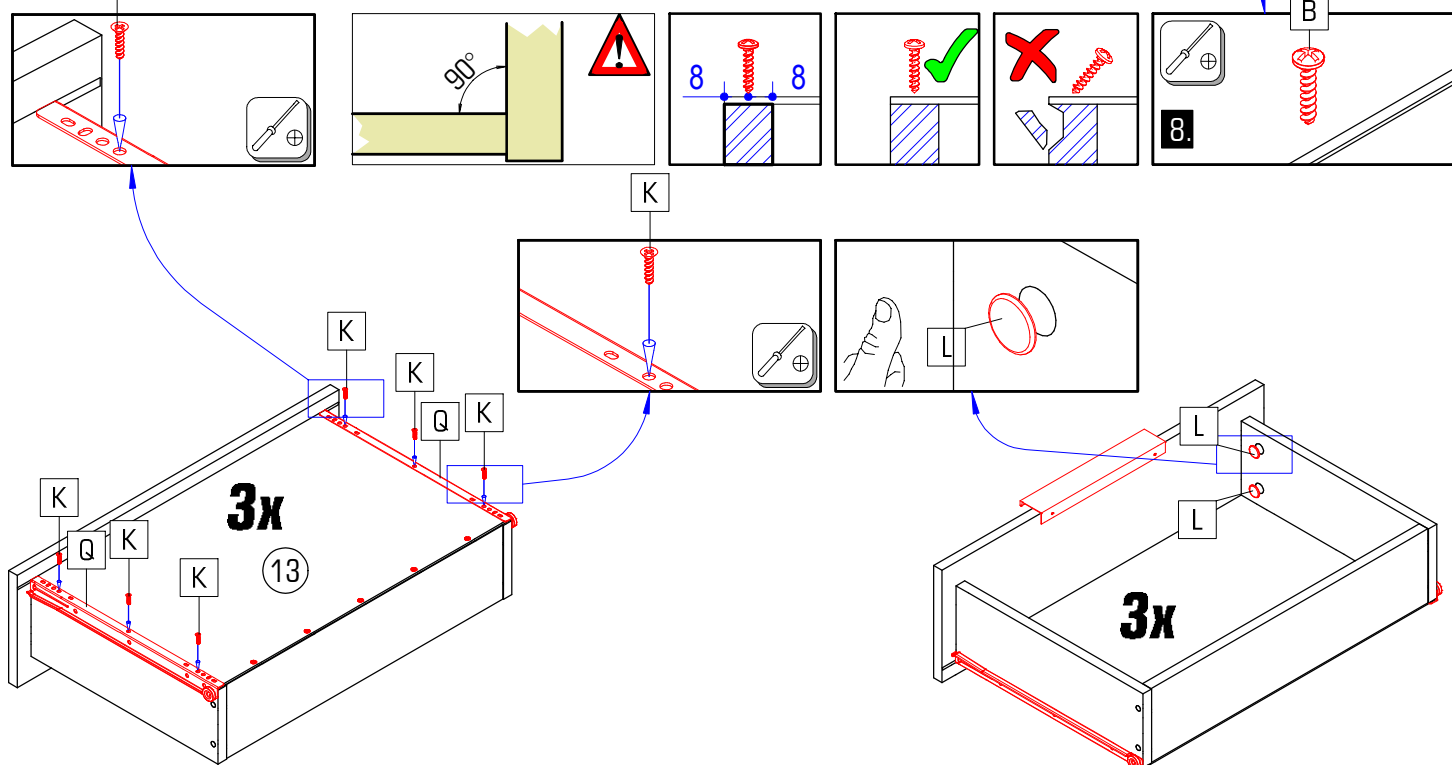
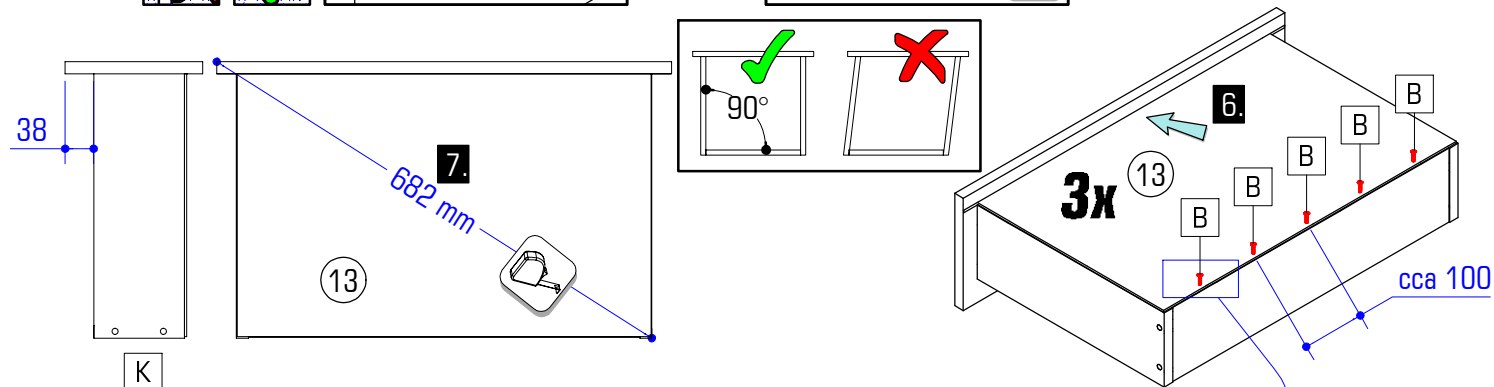
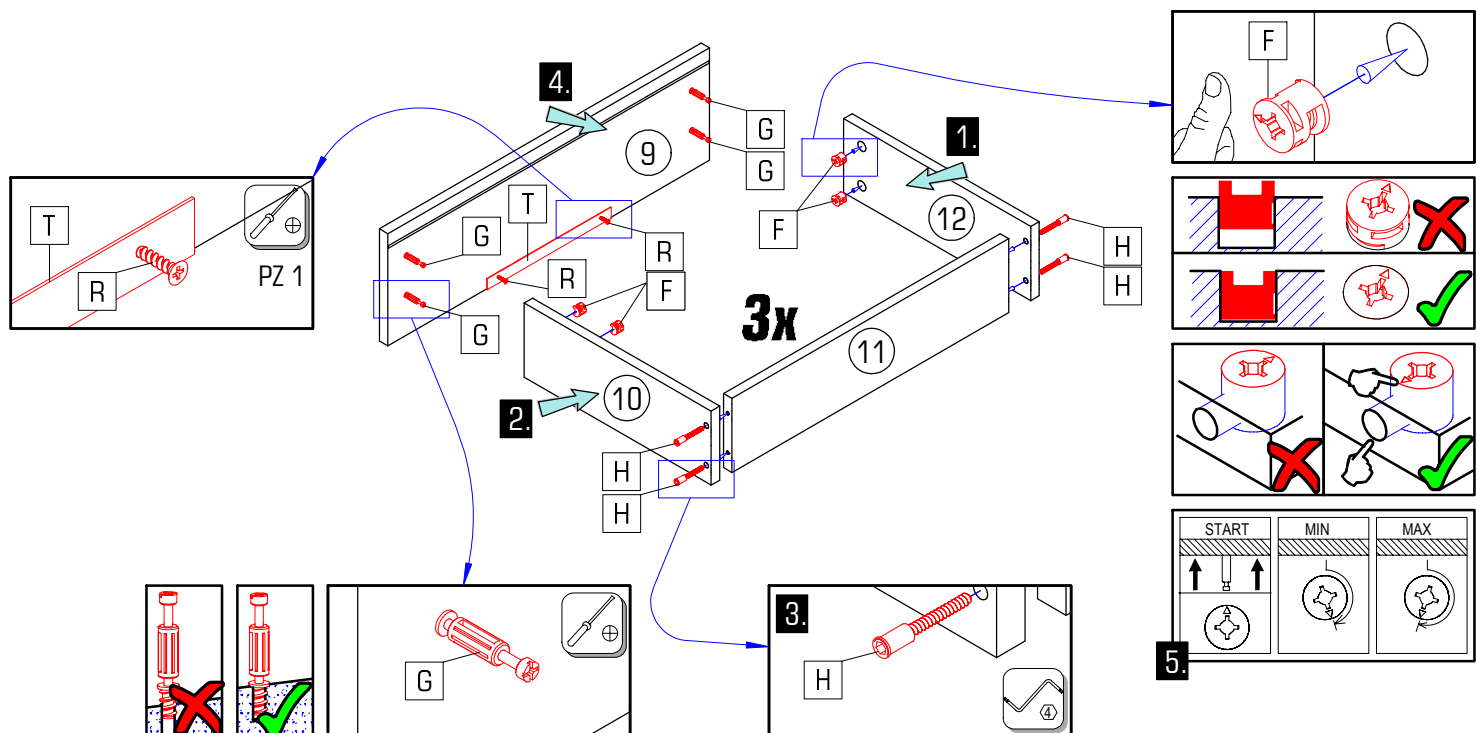

								
B 15x	L 12x	F 12x	G 12x	H 12x	K 18x	Q 3x	R 6x	T 3x



		
D	F	G
10x	10x	10x

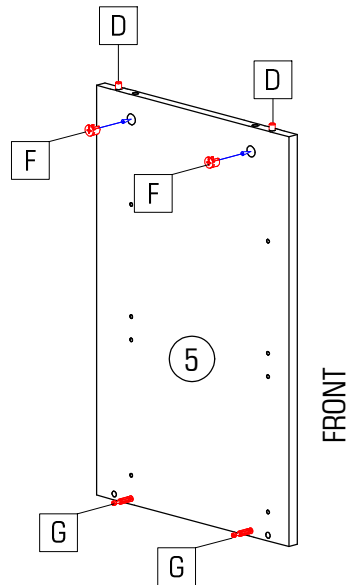
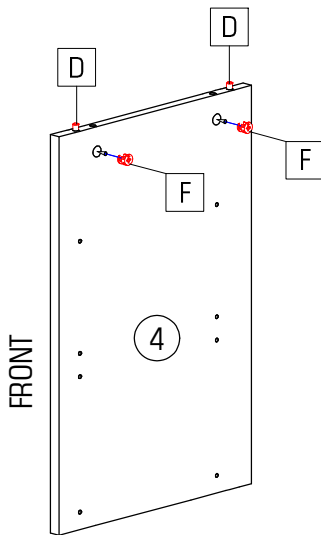
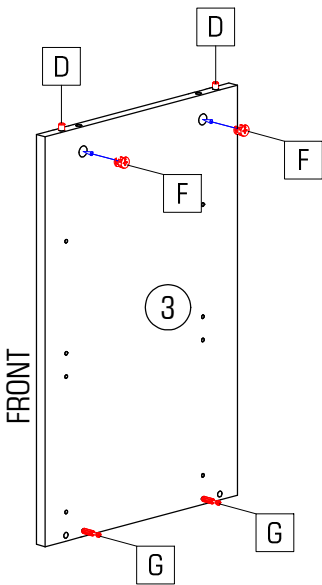
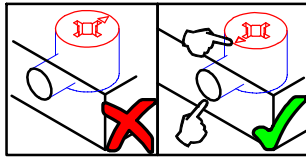
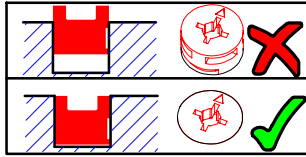
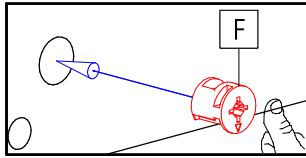
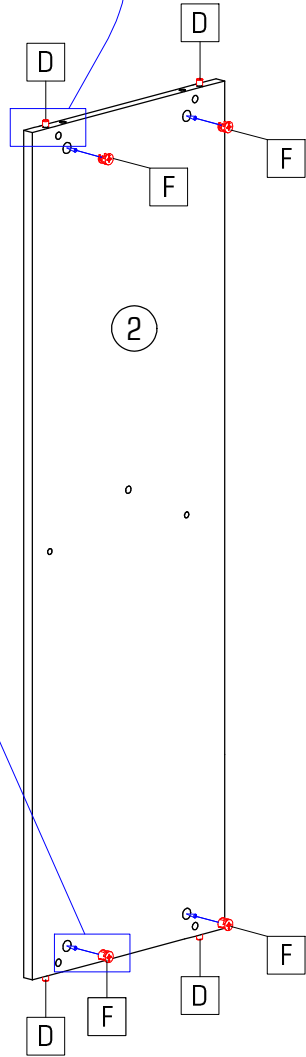
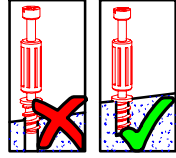
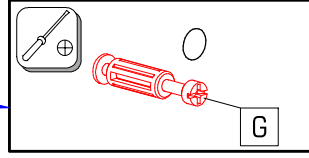
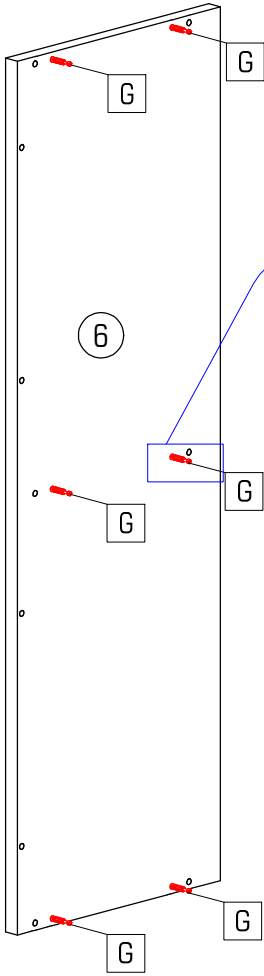
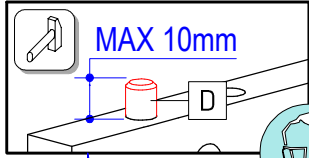
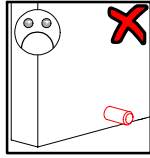
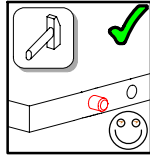

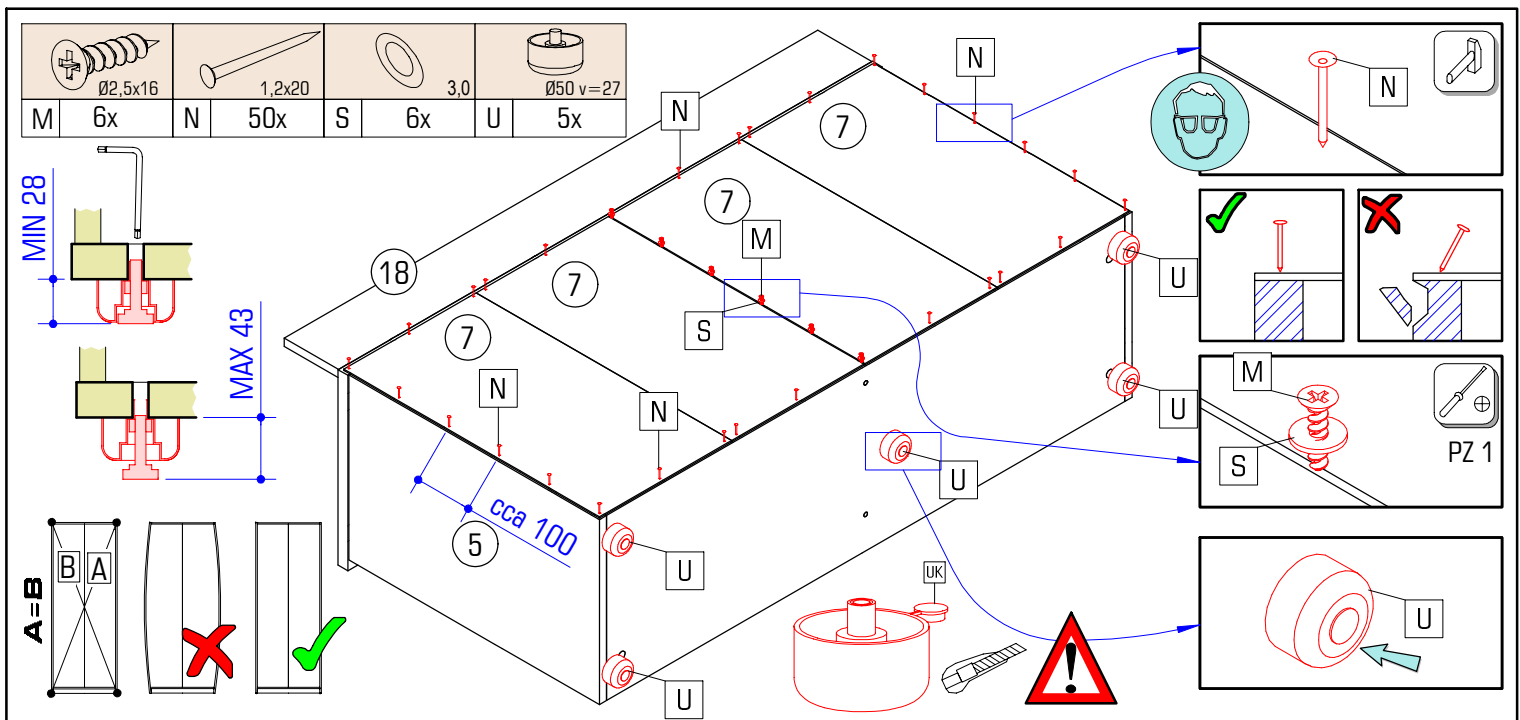
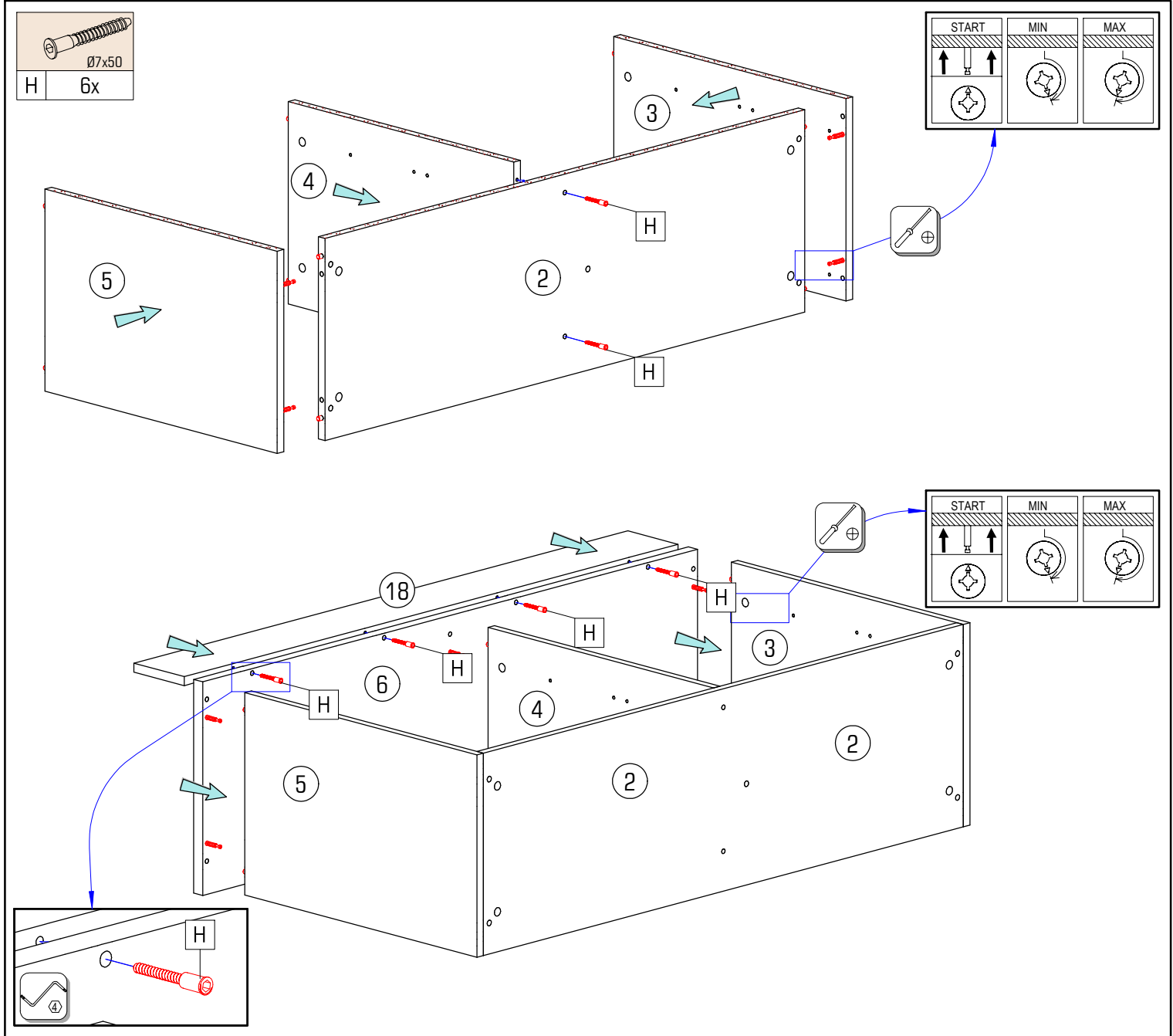





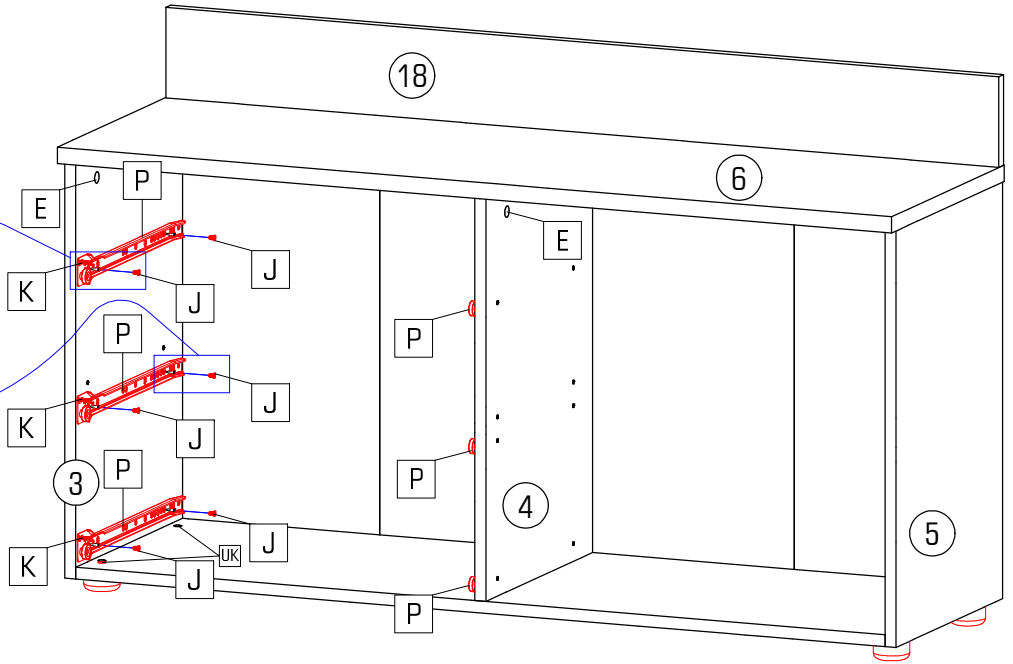
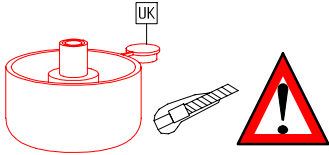
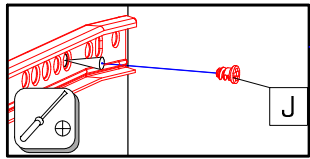
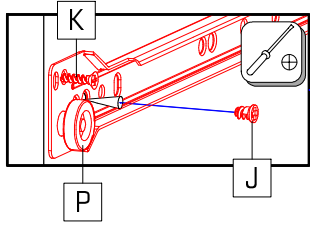

E	J	K	P
4x	12x	6x	3x
	Ø6,3x8	Ø3,5x15	L=350

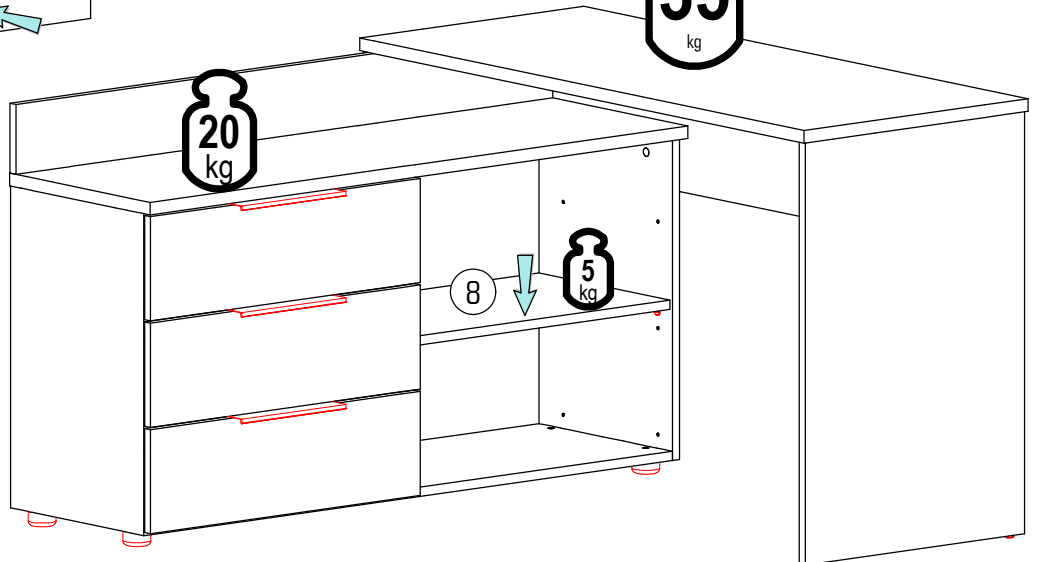
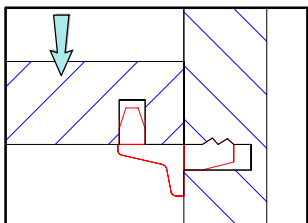
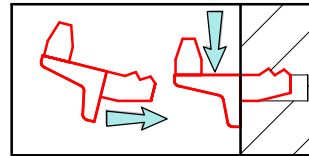
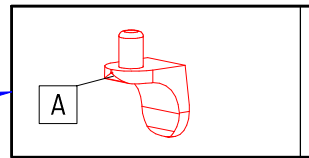
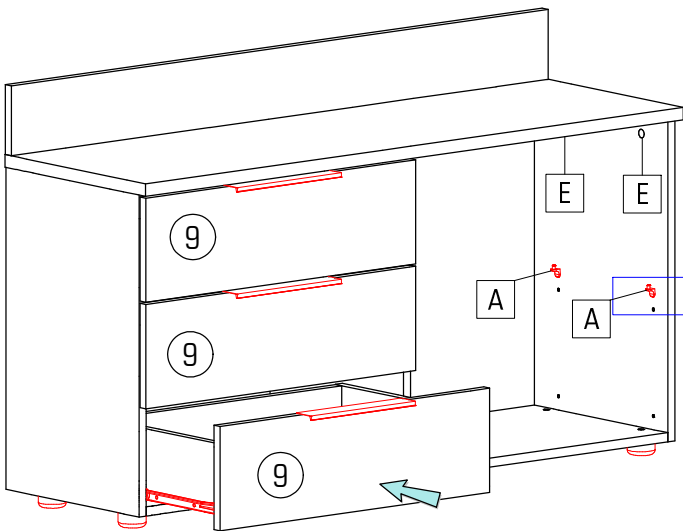



A	E	L
4x	7x	4x

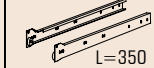

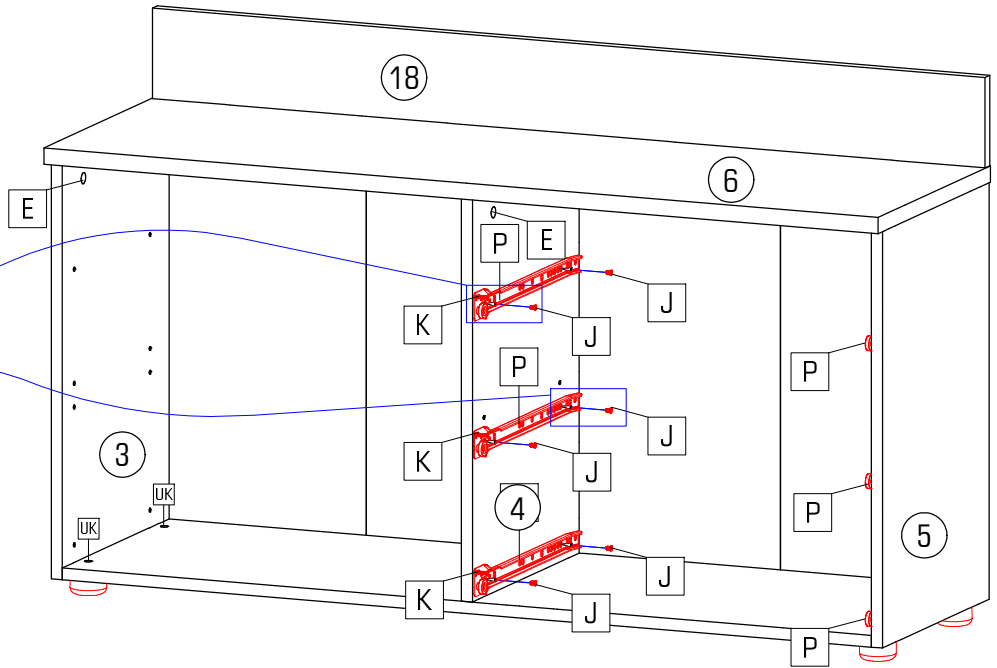
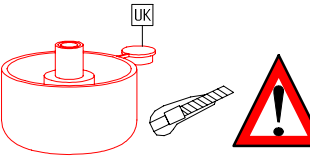
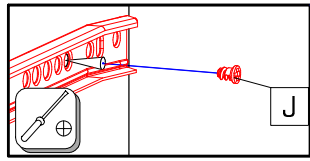
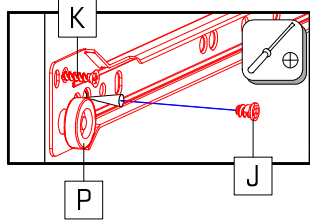
			
E 4x	J 12x	K 6x	P 3x



		
A 4x	E 7x	L 4x

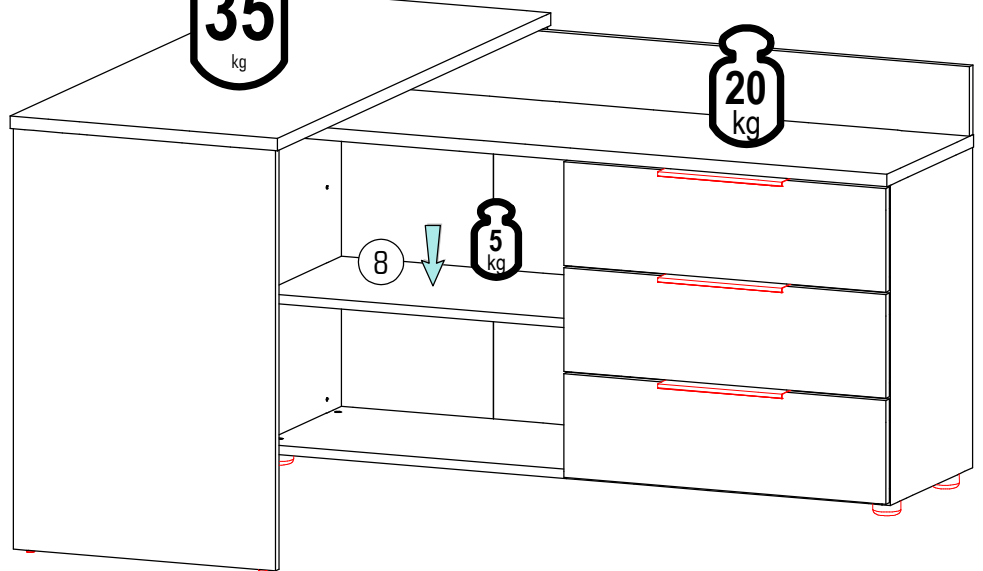
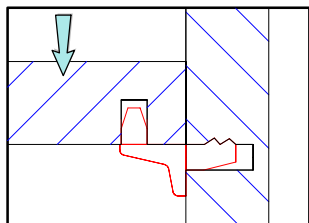
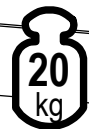
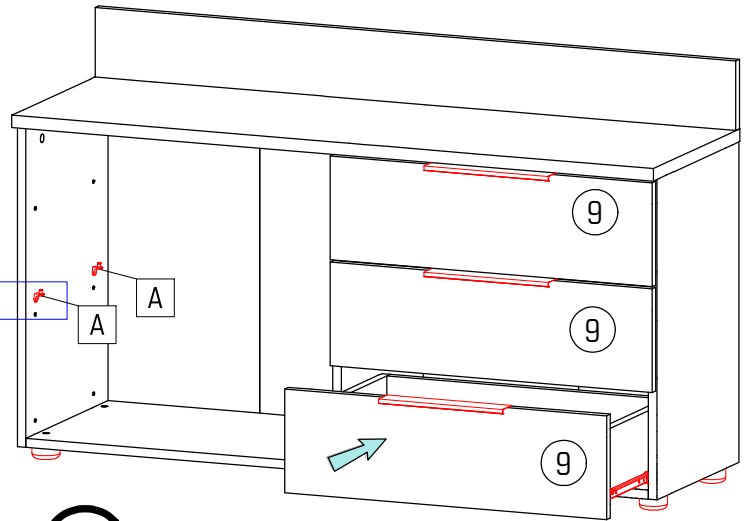
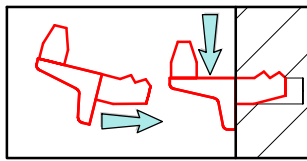
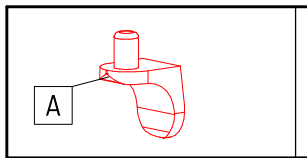

## A

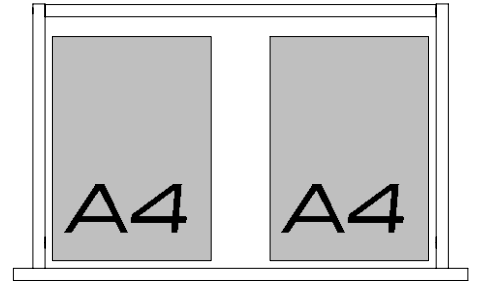
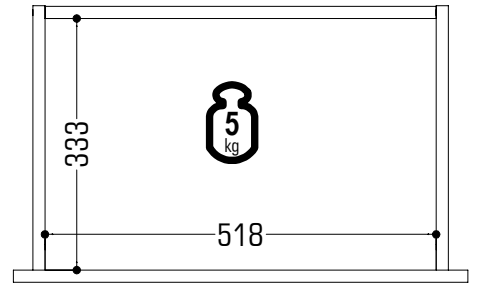
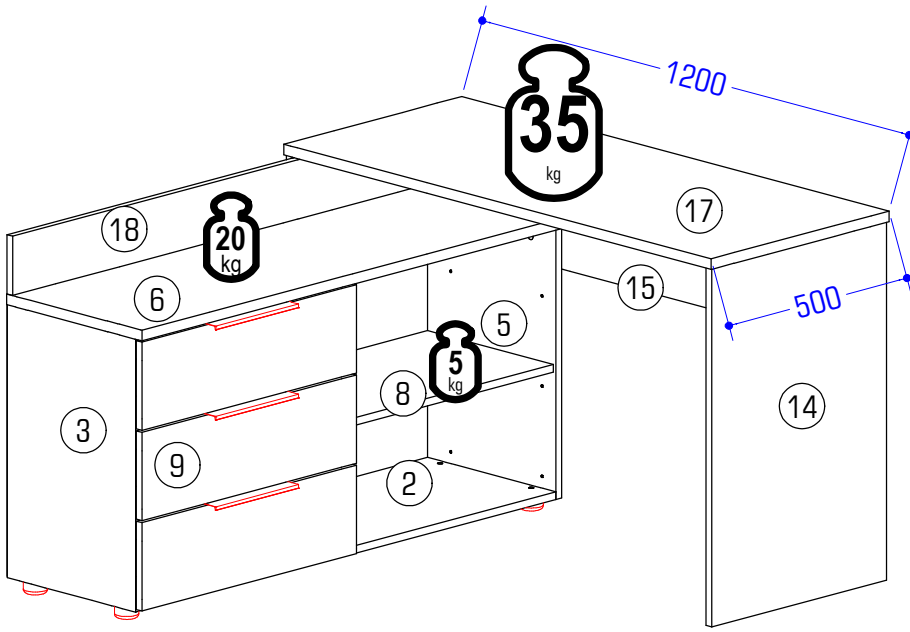

## B

